



Zehnder ComfoClima 24 with ComfoAir Q350

Product data sheet

always the best climate



ComfoClime 24 with ComfoAir Q350

The Zehnder ComfoClime 24 is our next generation air temperation device designed to help reduce the risk of overheating in homes and supplement heat in the winter. It combines with the ComfoAir Q350 or Q450 and compliments its features to ensure it automatically activates and deactivates to provide a comfortable, healthy and energy-efficient indoor climate. The Zehnder ComfoAir Q, with state of the art design and intelligent technology, regardless of whether you are working on a new build or an old building, with Zehnder comfortable ventilation you have an innovative, tried and tested complete system. It contains features such as its automatic modulating true summer by-pass, world class heat recovery efficiency and integrated humidity sensor to provide a comfortable, healthy and energy-efficient indoor climate.



Example controls - sold separately



Key Benefits

ComfoClime 24

- Up to 1.5 kW cooling capacity.
- Up to 1.4 kW heating capacity.
- Independently tested cooling and heating capacity to [EN 14511](#) and [EN 16573](#)
- Fully automatic activation of ComfoClime and increased ventilation rate in summer and winter, with automatic enabling due to Climate Switch technology without the need for user intervention.
- Easy and space-saving installation of left or right handed units directly on top of the Zehnder ComfoAir Q350.
- Left or right hand configuration through software alone, no mechanical alteration required.
- Choice of left or right handed condensate trap for flexibility on site.
- No external device required, just utilise the ventilation units ductwork.
- Filtered fresh supply air, not recycled stale air, using [ISO Coarse](#) (G4) as standard with the option to upgrade to [ISO ePM1](#) (F7).
- The 3rd generation of air temperation device from Zehnder, with over 5000 previous units sold and successfully installed world wide.
- Integral sensor for activation based on whole house internal temperature, no risk of false readings due to external sensors cited near appliances, radiators or in direct sunlight.
- Simple clean the only maintenance required once every 2 years.
- Front access for ease of service/maintenance or in situ end of life replacement.
- Wi-Fi enabled as standard for use with the ComfoControl app for IOS or Android.
- Controlled via the CAQ350's variety of controller options including ComfoSense C, KNX or ComfoControl app for IOS or Android.

ComfoAir Q350

- World class 96% efficiency.
- 100% full and filtered modulating summer bypass.
- Left or right hand configuration through software alone, no mechanical alteration required.
- Commissioning wizard for a quick and simple set-up process.
- Flow control to maintain commissioned flow rates.
- Adaptive comfort technology.
- Automatic passive temperature boost in summer.
- Humidity boost continuously monitors the humidity level within the home and looks for a man-made spike before boosting the unit.
- Tool free filter access.
- [ISO Coarse](#) (G4), [ISO ePM10](#) (M5) and [ISO ePM1](#) (F7) filter options.
- App for installer and end user option.
- Wireless commissioning option.
- Remote access option.
- KNX compatibility option.
- 0-10V input option.
- Internal pre-heater option.
- Post heater control option.
- Enthalpy cube option.
- Passive House certified.

Article Numbers

Description	Product Code
Unit	
Zehnder ComfoClime 24 for Zehnder ComfoAir Q350/450 w/o adaptor set	471 420 070
Zehnder ComfoAir Q350	471 502 015
Zehnder ComfoAir Q350 with pre-heater, right handed	471 502 016
Zehnder ComfoAir Q350 with pre-heater, left handed	471 502 017
Zehnder ComfoAir Q350 with enthalpy exchanger	471 502 018
Controls	
Controls, Zehnder ComfoSense C 67 remote display for Zehnder ComfoAir Q350/450/600, incl. mounting box	655 010 235
Controls, Zehnder ComfoSwitch C 67 speed controller for Zehnder ComfoAir Q350/450/600, incl. mounting box	655 010 255
Controls, ComfoControl RFZ wireless controller for use with ComfoSense 67/C67 (CCRFZ)	655 000 755
Controls, ComfoControl RFZ Timer wireless controller for use with ComfoSense 67/C67	655 000 780
Controls, Zehnder ComfoConnect KNX C for ComfoAir Q350/450/600	655 011 120
Controls, Zehnder ComfoConnect LAN C for ComfoAir Q350/450/600	655 011 100
Controls, Zehnder Option Box V2 Lite with additional connectivity for Zehnder ComfoAir Q350/450/600	471 502 143
Controls, Zehnder ComfoSplitter for ComfoAir Q350/450/600	655 010 275
Zehnder RF-PCB to offer wireless connectivity to the CCRFZ without the use of a ComfoSense C67	400 502 016
Controls CO2 C67, ComfoNET connection only, sensor and combined three position switch, incl. mounting box	655 000 885
Controls 12V 0-10V CO2 sensor and combined three position switch, incl. mounting box	655 000 855
Controls, Zehnder ComfoConnect PRO BMS interface for Zehnder ComfoAir Q350/450/600	471 429 300
Filters	
Filter for Zehnder ComfoAir Q350/450/600, ISO Coarse (G4), 2 Pieces	400 502 012
Filter for Zehnder ComfoAir Q350/450/600, ISO Coarse (G4), 10 Pieces	400 502 014
Filter for Zehnder ComfoAir Q350/450/600, ISO Coarse / ISO ePM10 activated carbon (G4/M5), 2 Pieces	400 100 097
Filter for Zehnder ComfoAir Q350/450/600, ISO ePM10 activated carbon (M5), 2 Pieces	400 100 165
Filter for Zehnder ComfoAir Q350/450/600, ISO Coarse / ISO ePM10 (G4/M5), 2 Pieces	400 102 099
Filter for Zehnder ComfoAir Q350/450/600, ISO Coarse / ISO ePM1 (G4 / F7), 2 Pieces	400 502 013
Filter for Zehnder ComfoAir Q350/450/600, ISO ePM1 (F7), 10 Pieces	400 502 015
Support Frame	
Support frame for Zehnder ComfoAir Q350/450/600, height 252 mm	471 502 008
Accessories	
Heat exchanger for Zehnder ComfoAir Q350/450/600	400 502 008
Enthalpy exchanger for Zehnder ComfoAir Q350/450/600	400 502 010
Condensation water drain kit for Zehnder ComfoClime	736 000 085
Zehnder ComfoPipe ø 160 mm, 45° bend	990 328 694
Adaptor set for ComfoClime to ComfoAir Q350	990 328 764
Adaptor for ComfoClime 24 to steel ducting ø 200mm with gasket seals, galvanised	990 326 357

SAP PCDB

	SFP (W/l/s)		Efficiency (%)	
	2009	2012	2009	2012
K+1	-	0.60	-	96%
K+2	0.60	0.53	96%	95%
K+3	0.51	0.57	95%	94%
K+4	0.50	0.64	95%	94%
K+5	0.54	0.72	94%	93%
K+6	0.60	0.89	94%	93%
K+7	0.68	1.03	94%	93%

SEC Class



Based on average climate with local demand control

Passive House Certification

	Standard heat exchanger	Enthalpy heat exchanger
Air flow range	70-270 m ³ /hr	70-270 m ³ /hr
Heat recovery rate	HR = 91%	HR = 86%
Specific electric power	Pel,spec = 0.24 Wh/m ³	Pel,spec = 0.22 Wh/m ³
Humidity recovery		x = 73%

Air flow range	71-270 m ³ /hr	71-262 m ³ /hr
Cold recovery rate	HR = 87%	HR = 81%
Specific electric power	Pel,spec = 0.22 Wh/m ³	Pel,spec = 0.21 Wh/m ³
Humidity recovery		x = 75%



Pressure Curve

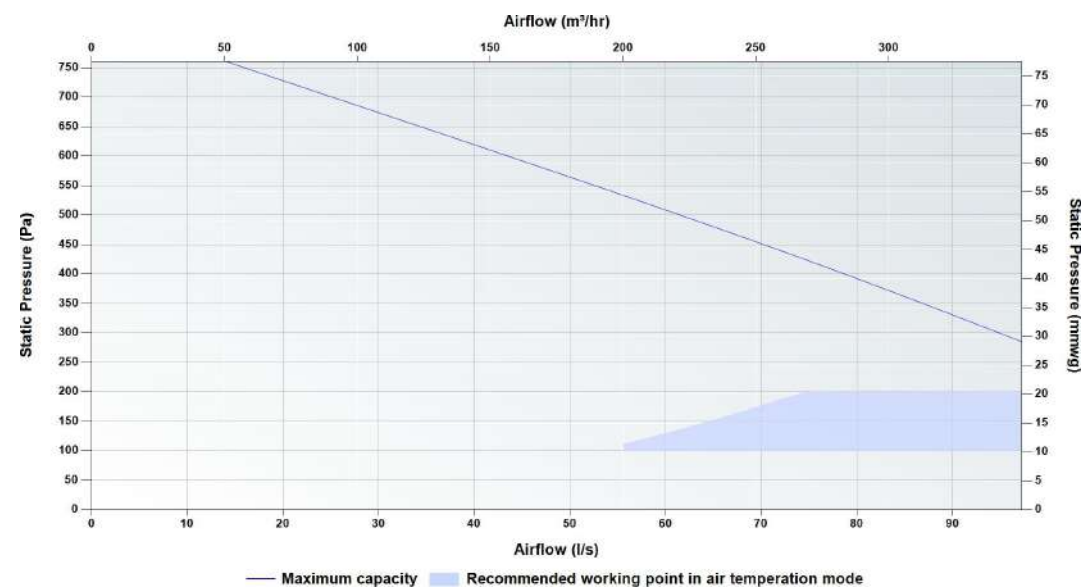

Resistance Guard cap at 400Pa

Sound Data

Speed	Test area	Octave Band (Hz) Sound Power Level, dB							dB(A) @ 3 m
		125	250	500	1000	2000	4000	8000	
20%	Casing ComfoClime on	34.7	26.3	27.2	18.6	10.4	13.6	27.6	12.2
	Supply ComfoClime off	41.5	32.4	31.9	17.0	1.6	1.3	28.2	
	Supply ComfoClime on	43.5	34.4	33.9	19.0	3.6	3.3	30.2	
40%	Extract ComfoClime on	39.3	26.9	21.7	12.0	10.3	15.6	24.7	18.1
	Casing ComfoClime on	40.5	36.4	35.8	26.9	20.8	20.3	25.4	
	Supply ComfoClime off	47.9	42.7	40.6	27.3	14.8	12.7	25.8	
60%	Supply ComfoClime on	49.9	44.7	42.6	29.3	16.8	14.7	27.8	25.9
	Extract ComfoClime on	44.8	36.9	30.7	19.8	16.3	18.3	23.1	
	Casing ComfoClime on	45.8	45.7	43.7	34.6	30.4	26.6	23.3	
80%	Supply ComfoClime off	53.8	52.3	48.7	36.8	27.1	23.2	23.6	34.7
	Supply ComfoClime on	55.8	54.3	50.7	38.8	29.1	25.2	25.6	
	Extract ComfoClime on	49.8	46.1	39.0	26.9	21.9	20.8	21.6	
100%	Casing ComfoClime on	51.5	55.6	52.1	42.8	40.7	33.3	21.2	36.6
	Supply ComfoClime off	60.1	62.5	57.4	46.9	40.2	34.5	21.2	
	Supply ComfoClime on	62.1	64.5	59.4	48.9	42.2	36.5	23.2	
100%	Extract ComfoClime on	55.1	56.0	47.9	34.5	27.8	23.4	20.0	36.6
	Casing ComfoClime on	52.7	57.7	53.9	44.6	42.9	34.7	20.7	
	Supply ComfoClime off	61.4	64.7	59.2	49.1	43.0	36.9	20.7	
100%	Supply ComfoClime on	63.4	66.7	61.2	51.1	45.0	38.9	22.7	36.6
100%	Extract ComfoClime on	56.3	58.1	49.8	36.1	29.1	24.0	19.7	

Casing, supply and extract tested according to ISO 3741:2010 showing induct sound power level corrected for end duct reflection according EN 13053:2019. Casing dB(A) @ 3 m given as hemispherical.

Technical Specification

Weight (ComfoClime / Combined with ComfoAir Q350)	62 / 112 Kg
Ducting ø	Internal - 175 mm
Condensate connection ø	32 mm
Filter grade	Standard - ISO Coarse / ISO Coarse (G4 / G4) Optional - ISO Coarse / ISO ePM1 (G4 / F7)
Materials	Internal EPP / ABS External coated sheet steel

ComfoClime	
Supply voltage	230 V / single-phase / 50Hz
Maximum power consumption	1100 W
Current draw	4.87 A
Fuse rating	6 amp
Refrigerant	R32
Refrigerant volume	0.65 kg
EER	up to 3.46
Cooling capacity	Up to 1.5 kW
Heating capacity	Up to 1.4 kW
Global Warming Potential (AR4)	675

ComfoAir Q350	
Supply voltage	230 V / single-phase / 50Hz
Maximum power consumption including / excluding pre-heater	1850 W / 180 W
Current draw including / excluding pre-heater	10.0 A / 1.42 A
Fuse rating including / excluding pre-heater	10 / 3 amp
Specific Fan Power	0.5 W/l/s
Heat Recovery Efficiency	96%
Preheater power	1.7 kW

Dimensions

Height with / without turnable bends	2027 / 1951.4 mm
Width with / without turnable bends	859 / 720.7 mm
Depth	570 mm

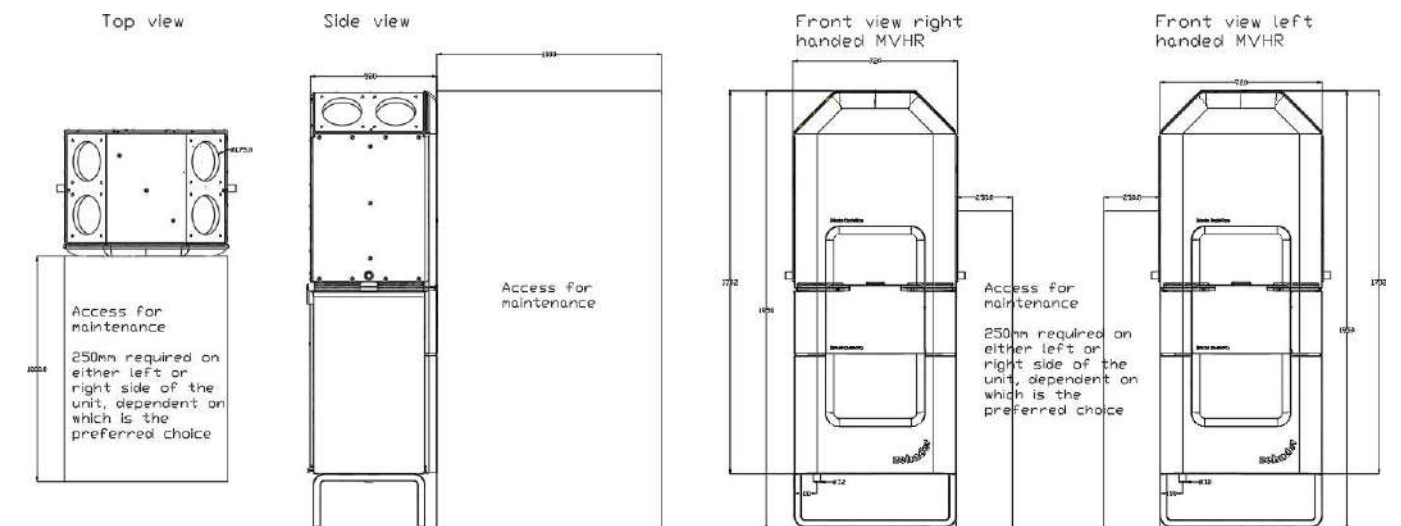

Performance Data

Air temperature									
External conditions		Internal conditions		Air flow		CC24		Total CAQ + CC24	
Dry bulb temp °C	Wet bumb temp °C	Dry bulb temp °C	Wet bumb temp °C	I/s / m³hr	Power IN W	COP/EER	Cooling capacity W	COP/EER	Cooling capacity W
35	24	27	19	62 / 225 90 / 327	319 500	2.60 2.67	831 1333	4.58 4.26	1660 2435
31	22	27	19	62 / 224 90 / 326	295 515	2.97 2.99	877 1540	3.98 3.55	1291 2078
27	19	27	19	63 / 229 90 / 325	259 397	3.23 3.46	837 1372	2.83 2.79	813 1298

Supplementary heating									
External conditions		Internal conditions		Air flow		CC24		Total CAQ + CC24	
Dry bulb temp °C	Wet bumb temp °C	Dry bulb temp °C	Wet bumb temp °C	I/s / m³hr	Power IN W	COP/EER	Heating capacity W	COP/EER	Heating capacity W
-7	-8	20	12	50 / 181 73 / 265 94 / 340	292 520 536	1.90 2.19 2.51	746 1138 1344	5 4.76 5.06	2428 3499 4118
2	1	20	12	53 / 193 76 / 276	410 538	2.04 2.36	837 1272	4.46 4.73	1952 2823
7	6	20	12	57 / 207 79 / 285	424 520	2.48 2.71	1053 1407	3.88 4.09	1752 2375

Capacities tested according to EN 14511 and EN 16573 within a climatic chamber

Air Direction/Connection

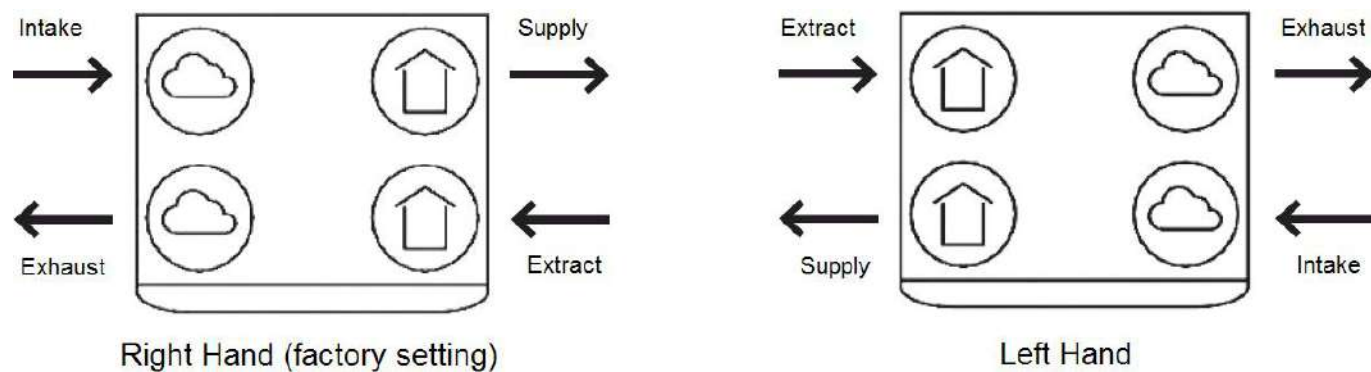

Wiring

Electrical connections should be carried out in accordance to IEE regulations by a qualified electrician. The unit is supplied with a flying lead for connection to the mains supply.

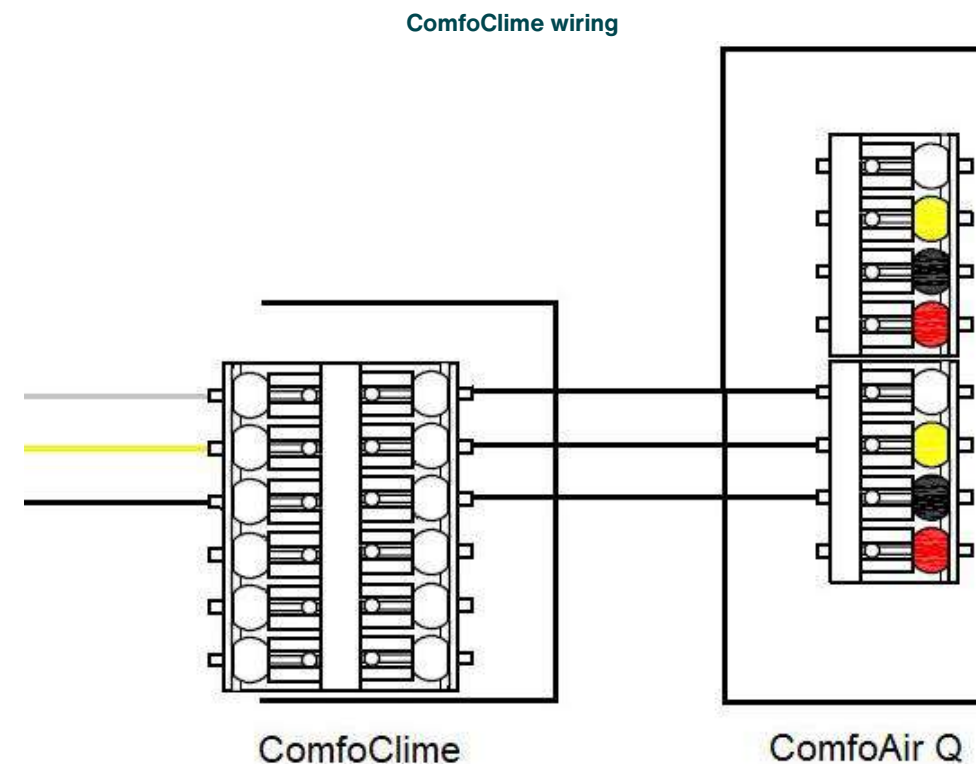

3 core cable, 1.5mm Max.
(up to 50 metres)

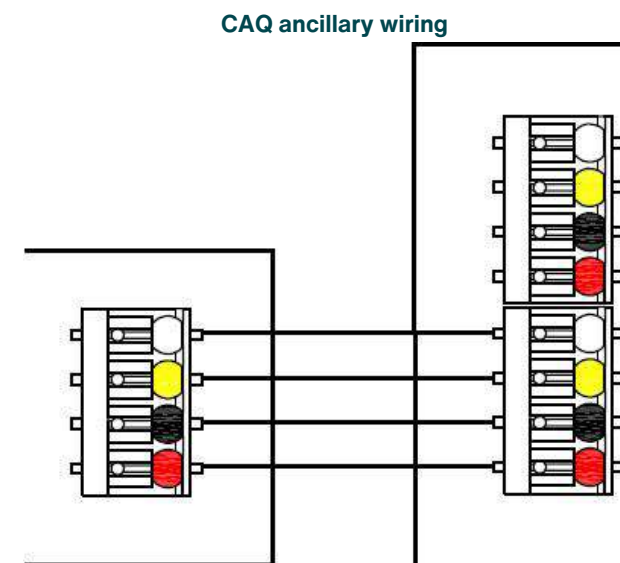

4 core cable, 1.5mm Max.
(up to 50 metres)

Zehnder ComfoPipe \varnothing 160 mm, 45° bend

Article number: 990 328 694

Description

Insulated bend:

Insulated bend available in 45°, two can be combined to form 90°. Each bend comes complete with a premoulded single male connector to securely connect to a straight length of insulated duct or another 45° bend. Can connect directly to the top of the ComfoClima 24. One bend is required per spigot.

Technical Specification

Angle	45°
Outside diameter	190 mm
Inside diameter	160 mm
Height	243.8 mm
Width	235.1 mm
Depth	190 mm
Weight	0.05 kg



Dimensions

Front View

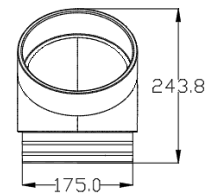

Side View

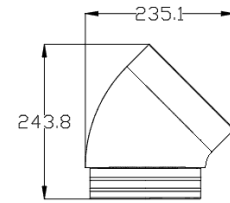

Top View

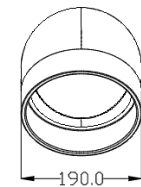

Adaptor set for ComfoClima to ComfoAir Q350

Article number: 990 328 764

Description

Adaptor set:

EPP adaptor to connect ComfoAir Q350 to ComfoClima. The adaptor is supplied with 4 spigot seals and fixing screws, with one set being required with each ComfoClima.

Technical Specification

Weight	1.16 kg
Material	Expanded Polypropylene (EPP)



Adaptor for ComfoClima 24 to steel ducting \varnothing 200mm with gasket seals, galvanised

Article number: 990 326 357

Description

Adaptor:

Galvanised steel adaptor \varnothing 175 mm ducting to \varnothing 200 mm. The rigid adaptor with attenuation properties can be placed into the ComfoClima 24 spigot to convert it to \varnothing 200 mm ductwork where existing ComfoCool Q design width restrictions are in place. One adaptor is required per side.

Technical Specification

Height	261 mm
Width	225.5 mm
Depth	485 mm
Weight	4.9 kg



Dimensions

Front View

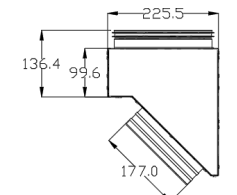

Side View

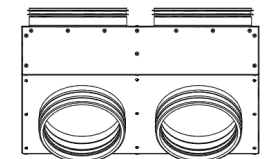

Top View

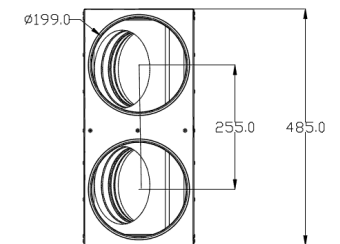

Pressure Curve

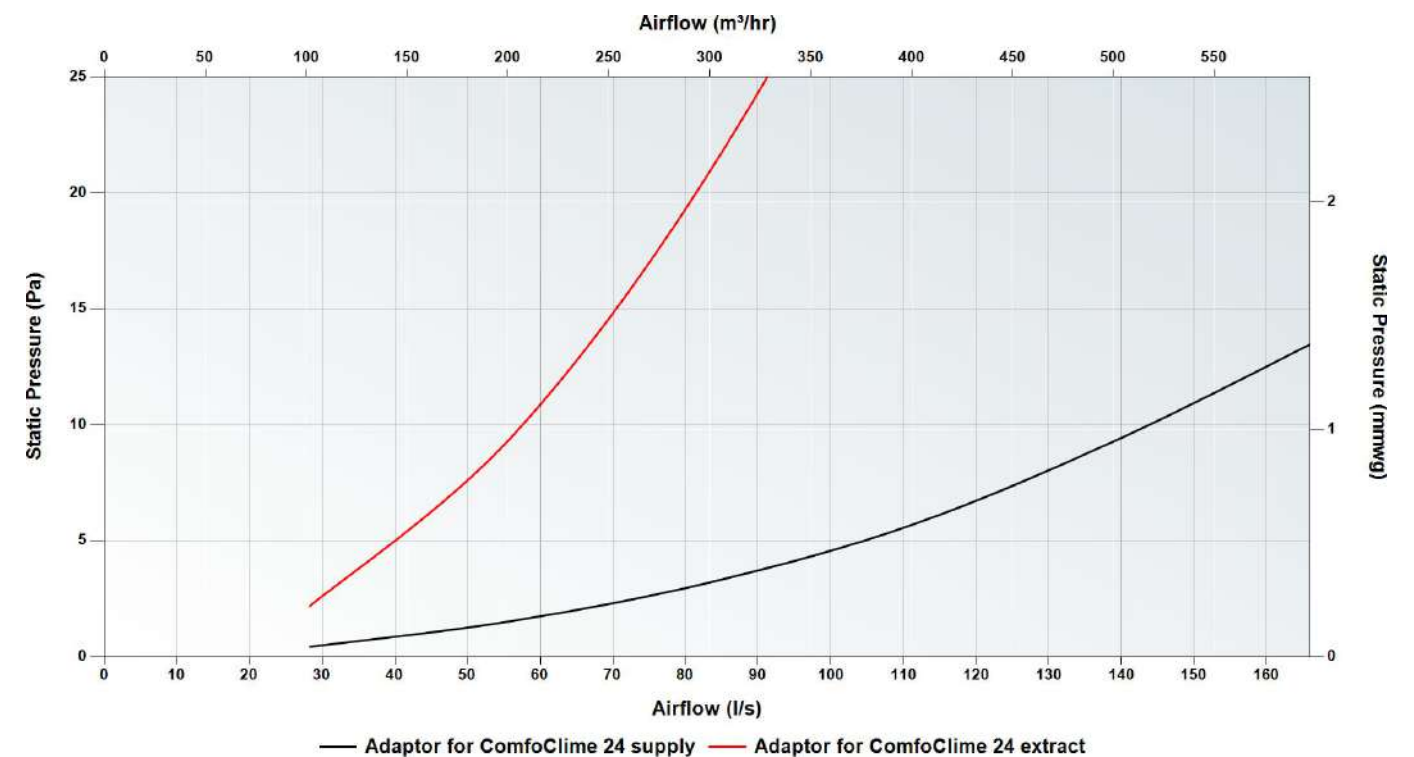

Resistance Guard cap at 400Pa

Controls

ComfoSense C67

Product code: 655 010 235



The Zehnder ComfoSense C67 is a four position switch designed to enable the user to manually select the desired ventilation systems flow rate and provide system notifications

Key Benefits

- 4 separate ventilation flow rate options to select in 1 controller
- 7 day flow rate programmer
- Summer bypass indicator
- Frost protection indicator
- Service and Maintenance alert
- Clock function
- User menu access
- RF bridge to enable use of the CCRFZ (655 000 755) controller

Technical Specification

Mounting options	Recessed / Surface
Supply voltage	Low voltage direct from the MVHR units ComfoNET connector
IP rating	IP44
Recommended cable	4 core cable, 1 mm Max. (up to 50 metres)
RAL colour	9016
Maximum number per unit	2 (3/6 if using ComfoSplitter unpowered/powered)
Supplied mounting box	655 010 270

Dimensions (recessed)

Height	80 mm
Width	80 mm
Depth	12 mm

Dimensions (surface mounted)

Height	80 mm
Width	80 mm
Depth	48.5 mm

ComfoSwitch C67

Product code: 655 010 255



The Zehnder ComfoSwitch C67 is a four position switch designed to enable the user to manually select the desired ventilation systems flow rate and provide system notifications

Key Benefits

- 4 separate ventilation flow rate options to select in 1 controller
- Temporary high speed activation setting
- Service and Maintenance alert

Technical Specification

Mounting options	Recessed / Surface
Supply voltage	Low voltage direct from the MVHR units ComfoNET connector
IP rating	IP44
Recommended cable	4 core cable, 1 mm Max. (up to 50 metres)
RAL colour	9016
Maximum number per unit	2 (3/6 if using ComfoSplitter unpowered/powered)
Supplied mounting box	655 010 270

Dimensions (recessed)

Height	80 mm
Width	80 mm
Depth	12 mm

Dimensions (surface mounted)

Height	80 mm
Width	80 mm
Depth	48.5 mm

ComfoControl RFZ

Product code: 655 000 755



The Zehnder CCRFZ is a three position switch designed to enable the user to manually select the desired ventilation systems flow rate and provide system notifications. This controller can only be used in conjunction with the ComfoSense or ComfoSense C.

Key Benefits

- Wireless controller
- 3 separate ventilation flow rate options to select in 1 controller
- 2 temporary high speed activation settings
- Service and Maintenance alert

Technical Specification

Mounting options	Surface
Supply voltage	Powered by a coin cell lithium battery (type: CR 2032)
IP rating	IP40
RAL colour	9010
Maximum number per unit	40

Dimensions (surface mounted)

Height	80 mm
Width	80 mm
Depth	14 mm

ComfoControl RFZT

Product code: 655 000 780



The Zehnder CCRFZT is a multi position switch designed to enable the user to manually select the desired overrun timer duration.

This controller can only be used in conjunction with the ComfoSense or ComfoSense C.

Key Benefits

- Wireless controller
- 3 separate ventilation overrun timer options to select in 1 controller
- Manual override to prematurely turn off the overrun timer
- Controller service and connection alert

Technical Specification

Mounting options	Surface
Supply voltage	Powered by a coin cell lithium battery (type: CR 2032)
IP rating	IP40
RAL colour	9010
Maximum number per unit	40

Dimensions (surface mounted)

Height	80 mm
Width	80 mm
Depth	14 mm

ComfoConnect KNX C

Product code: 655 011 120



The Zehnder ComfoConnect KNX C enables the connection between the ventilation system and the KNX building management system.

Key Benefits

- Control and monitor the ventilation system via the KNX building management system
- Control ventilation flow rate, temperature profile, temporary high speed setting and external sensor set points
- Monitor ventilation flow rates, temperatures and external sensors
- 7 day flow rate programmer
- Service and Maintenance alert
- ETS5 compatible

Technical Specification

Supply voltage	Low voltage direct from the MVHR units ComfoNET connector
IP rating	IP30
Recommended cable	4 core cable, 1 mm Max. (up to 50 metres)
RAL colour	Front: 9003 Back: 7024
Device model	System B
Supported configuration mode	S-Mode
Supported ETS version	5
Zehnder KNX library available at	https://www.zehnder.co.uk
Maximum number per unit	1

Dimensions (surface mounted)

Height	120 mm
Width	76 mm
Depth	25 mm

ComfoConnect LAN C

Product code: 655 011 100



The Zehnder ComfoConnect LAN C enables the connection between the ventilation system and the ComfoControl app for iPhone and android devices.

Key Benefits

- Control and monitor the ventilation system via the ComfoControl app
- Control ventilation flow rate, temperature profile, temporary high speed setting and external sensor set points
- Monitor ventilation flow rates, temperatures and external sensors
- 7 day flow rate programmer
- Access the ventilation system remotely from anywhere in the world
- Service and Maintenance alert direct to your phone
- User menu access
- Installer menu access



Zehnder ComfoControl App

Technical Specification

Supply voltage	Low voltage direct from the MVHR units ComfoNET connector
IP rating	IP30
Recommended cable	4 core cable, 1 mm Max. (up to 50 metres)
RAL colour	Front: 9003 Back: 7024
Maximum number per unit	1

Dimensions (surface mounted)

Height	120 mm
Width	76 mm
Depth	25 mm

Option Box V2 Lite

Product code: 471 502 143



The Zehnder Option Box V2 Lite enables the connection between the ventilation system and various other external components.

Key Benefits

- 4 x 0-10V inputs for use with the 12V 0-10V RH sensor or 12V 0-10V CO2 sensor
- Volt free contact input
- Post heater integration
- ComfoFond-L Q or sub-soil heat exchanger valve integration when combined with 400 300 311 power cable
- External filter alert integration
- Service mode activation input to disable fans e.g. when fire alarm activated

Technical Specification

Supply voltage	Low voltage direct from the MVHR units ComfoNET connector
IP rating	IP40
Recommended cable	4 core cable, 1 mm Max. (up to 50 metres)
RAL colour	Front: 9003 Back: 7024
Maximum number per unit	1

Dimensions (surface mounted)

Height	254 mm
Width	195 mm
Depth	60 mm

Wiring

The Bathroom Switch connection option - II

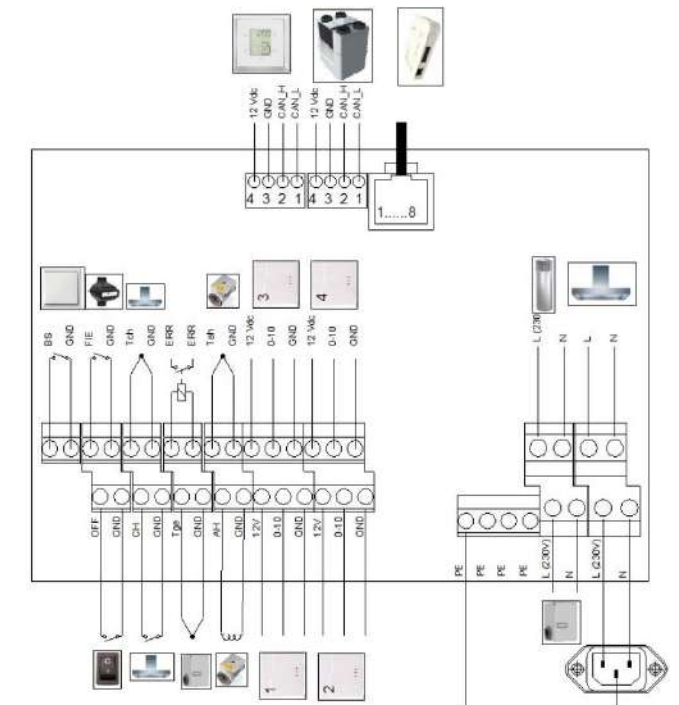
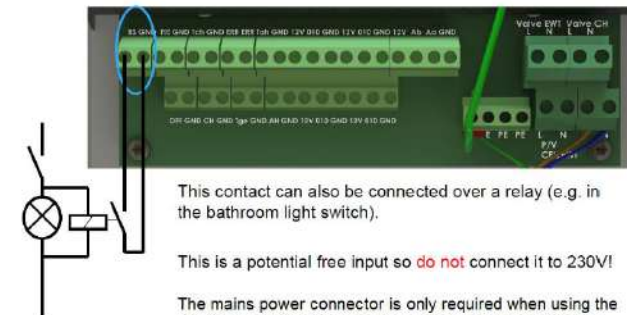

ComfoSplitter

Product code: 655 010 275



The Zehnder ComfoSplitter enables 5 additional ComfoNet connectivity options to the ventilation system.

Key Benefits

- 2 additional ComfoNet connectivity options when unpowered
- 5 additional ComfoNet connectivity options when powered

Technical Specification

Mounting options	Surface
Supply voltage	Low voltage direct from the MVHR units ComfoNET connector Mains power - 230 V / single-phase / 50Hz
IP rating	IP22
Recommended cable	4 core cable, 1 mm Max. (up to 50 metres)
RAL colour	9018
Maximum number per unit	1

Dimensions (surface mounted)

Height	108 mm
Width	53 mm
Depth	23 mm

RF-PCB - ComfoAir Q

Product code: 400 502 016



The Zehnder RF-PCB enables the CCRFZ (655 000 755) controller to be used with the ventilation system without the need for the ComfoSense C67.

Key Benefits

- Acts as a wireless receiver to the CCRFZ (655 000 755) controller without the need for the ComfoSense C67
- Built into the unit and not visible from the outside

Technical Specification

Mounting options	Inside the unit direct to the PCB
------------------	-----------------------------------

CO2 sensor C67

Product code: 655 000 885



The Zehnder CO2 sensor C67 is a remote CO2 sensor and combined three position switch designed to enable the user to manually select the desired ventilation systems flow rate based on the visual air quality indicator, or automatically adjust the unit relevant to the CO2 level.

Key Benefits

- Green, orange and red visual air quality indication light
- 3 separate ventilation flow rate options to temporarily select in 1 controller for manual 12hr override
- CO2 measuring range 0-2000 ppm
- Self-calibrating
- Discreet design
- Direct connection via ComfoNET (No need for Option Box)
- Daisychain connection available for when using multiple sensors

Technical Specification

Mounting options	Surface / Recessed
Supply voltage	Low voltage direct from the MVHR units ComfoNET connector
IP rating	IP30
Recommended cable	4 core cable, 1 mm Max. (up to 50 metres)
RAL colour	9016
Maximum number per unit	ComfoAir Q - 10 ComfoAir Flex - 4
Supplied mounting box	400 300 291

Dimensions (recessed)

Height	80 mm
Width	80 mm
Depth	12 mm

Dimensions (surface mounted)

Height	80 mm
Width	80 mm
Depth	43.5 mm

12V 0-10V CO2 sensor

Product code: 655 000 855



The Zehnder 12V 0-10V remote CO2 sensor and combined three position switch is designed to enable the user to manually select the desired ventilation systems flow rate based on the visual air quality indicator, or automatically adjust the unit relevant to the CO2 level.

Key Benefits

- Green, orange and red visual air quality indication light
- 3 separate ventilation flow rate options to temporarily select in 1 controller for manual 12hr override
- CO2 measuring range 0-2000 ppm
- 0-10V output corresponding to measured CO2
- Discreet design

Technical Specification

Mounting options	Surface / Recessed
Supply voltage	12 V DC voltage direct from the MVHR units PCB connector, or via Option Box V2 for ComfoAir Q
IP rating	IP30
Recommended cable	3 core cable, 1 mm Max. (up to 50 metres)
RAL colour	9016
Supplied mounting box	400 300 291

Dimensions (recessed)

Height	80 mm
Width	80 mm
Depth	12 mm

Dimensions (surface mounted)

Height	80 mm
Width	80 mm
Depth	43.5 mm

ComfoConnect PRO

Product code: 471 429 300



The Zehnder ComfoConnect PRO Modbus, Internet and app interface allows you to use the Zehnder ComfoControl app. The connection to the Zehnder device is wired via ComfoNET and LAN or wireless via Wi-Fi. Direct connection to a home automation system is also possible.

Key Benefits

- Automation protocols (Modbus RTU/TCP) with local / remote app control via cloud and technical support
- Digital security cryptographic keys, secure cloud platform and automatic software updates
- Compatible with a wide range of Zehnder ComfoNet II devices and accessories (Zehnder ComfoAir Q, Zehnder ComfoAir Flex, Zehnder ComfoSwitch C / ComfoSense C)

Technical Specification

Supply voltage	Low voltage direct from the MVHR units ComfoNET connector
IP rating	IPX0
Recommended cable	4 core cable, 1 mm Max. (up to 50 metres)
RAL colour	Front: 9003 Back: 7024
Maximum number per unit	1
Wi-Fi	2.4 GHz / 5 GHz
Ethernet	10/100 Mbit
Connectors	RS232 RS485
Communication protocols	Modbus TCP Modbus RTU
Compatible smart home manufacturers	Loxone Smart Place

Dimensions (surface mounted)

Height	133 mm
Width	90 mm
Depth	41 mm

Wiring

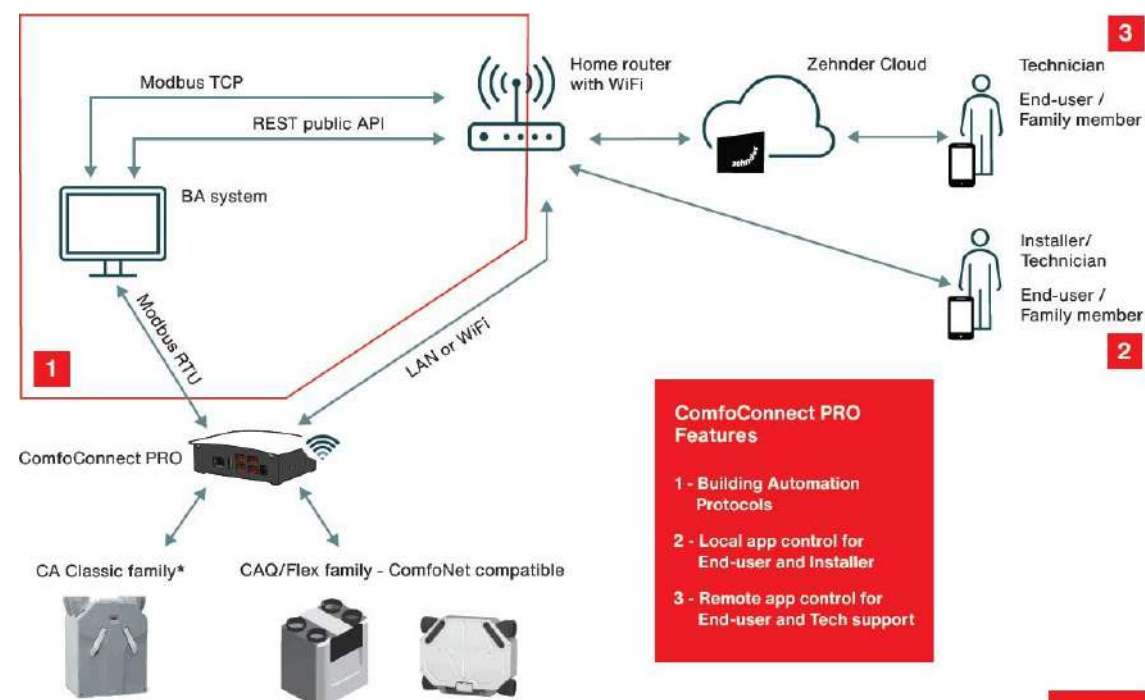

*ComfoAir 160, 180, 200, 225, 350, 450, 550, SL220, SL330, Standard 300, Standard 375 - Available from software release 1.1

For use with

Our range of ComfoClima units can be used in conjunction with our ComfoWell and ComfoTube Therm. The modular ComfoWell manifold can be combined with multiple circular connections for rigid round or semi-rigid connections. Along with filter boxes and attenuated manifold options, the ComfoWell is the perfect bespoke air distribution system for our ComfoAir MVHR units. The ComfoTube Therm has been specifically designed to reduce energy loss when transporting tempered air, to enable energy-efficient cooling and heating whilst maintain the flexibility of the ComfoTube semi-rigid ductwork..

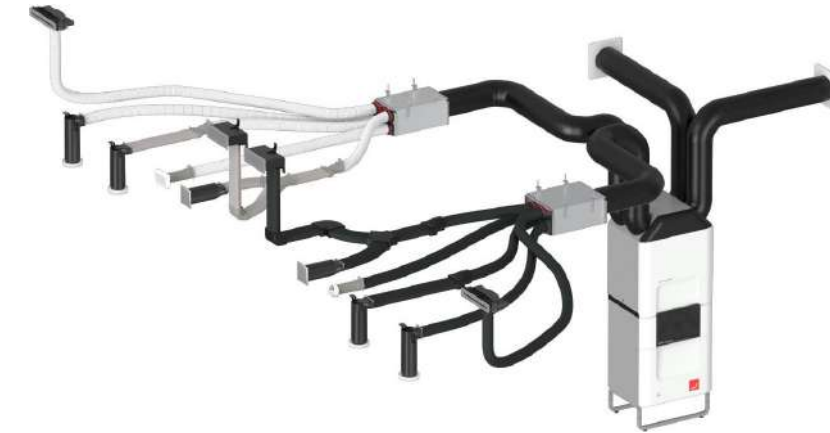

TO VIEW OUR COMFOTUBE THERM INFORMATION

[CLICK HERE](#)

BIM/CAD Components

If you would like to download the BIM / CAD files for this or any other of our products then please visit our BIM library.

TO VISIT OUR BIM/CAD LIBRARY

[CLICK HERE](#)

Installation Instructions

If you would like to download the installation files for this or any other of our products then please visit our download page by clicking the link below.

TO VISIT OUR DOWNLOAD PAGE

[CLICK HERE](#)

Our Informational Videos



Watch our video on how to install the Zehnder ComfoAir Q.

TO WATCH OUR VIDEO

[CLICK HERE](#)



Watch our video on how to install the Zehnder ComfoClime.

TO WATCH OUR VIDEO

[CLICK HERE](#)

Consultant Specification

Specification

The units shall consist of a body manufactured in powder coated steel. The units shall be fully insulated using high quality EPP to maintain excellent thermal and acoustic characteristics and prevent shrinkage over time. The air temperation unit shall be capable of working in conjunction with the whole house ventilation system with heat recovery ComfoAir Q350 or Q450, utilising the fresh and filtered external air. The air temperation unit shall temper the supply air from the ComfoAir Q350 or Q450 unit utilising a compression air temperation system. The air temperation unit shall contain a low toxicity, low flammability and zero ozone depletion coolant R32. The cooling and heating capacity must be independently tested to [EN 14511](#) and [EN 16573](#).

The air temperation unit shall be controlled by the average return temperature from the ComfoAir Q350 or Q450 unit.

The air temperation unit shall be constructed to have a removable cover to allow full maintenance access. The removable cover shall enable access to the electrical connections, sensors and cooling skid. The spare parts must be made available for a minimum of 10 years even after ceasing manufacture of the unit.

The ventilation unit shall have EC motors with sealed for life bearings. The fans impellers should be low pressure centrifugal type with backward curved blades within ABS scroll housing and flow ring to provide accurate pressure measurement and incorporate a flow grid to optimise the airflow into the fan. The heat exchanger shall be a diamond shaped multi-plate, counter flow design constructed from Polystyrene with laser welded joints and shall retain up to 96% of the temperature differential of outgoing air with the option to upgrade to an enthalpy heat exchanger for latent and sensible heat transfer plus moisture recovery negating the need for a condensate drain.

The ventilation unit shall contain filters manufactured from material which has been tested to a minimum of [ISO Coarse](#) (G4) standard with the option to upgrade to [ISO ePM1](#) (F7). The filters shall be pleated to reduce the pressure drop and required cleaning time. The ventilation unit shall have 160 mm duct connections, and be suitable for use with 220x90 mm ductwork. It shall be suitable for use with a floor stand with the ability to allow left or right hand configuration through the unit's software alone – no mechanical reconfiguration shall be required. Integrated modulating preheater options shall be available to regulate its output to enable balanced ventilation with external air temperatures -10°C.

The ventilation unit shall have a 100% full summer bypass using an in-line modulating mechanism to provide filtered supply air 365 days of the year, even under bypass conditions. It shall provide fresh filtered air to aid night time cooling and prevent condensation within the supply pipework, regardless of the external air temperature. The ventilation unit shall contain a temperature sensor for each air stream to ensure correct and logical operation of the bypass damper by evaluating differential as well as absolute temperature to maximise the opportunity for free cooling. The ventilation unit shall control air flow to react to prolonged, sustained increased pressure drops to best achieve the commissioned flow rate even when filter degradation occurs.

Airflow should not react to short term 'wind gusts' to avoid nuisance running.

The ventilation unit shall be constructed to have a removable cover to allow full maintenance access. The removable cover shall enable access to the supply/extract fan, heat exchanger and access to electrical connections. The motors shall be suitable for removal without the requirement for the unit to be removed from situ and be available as spare parts for a minimum of 10 years even after ceasing manufacture of the unit.

The units shall conform to LVD and EMC standards and be CE Marked in addition to having an EU compliant energy rating label (SEC) with a minimum grade of A. The units shall conform to [UK Electrical Equipment \(Safety\) Regulations](#) and [Electromagnetic Compatibility Regulations](#) and be UKCA Marked. The units shall be manufactured by Zehnder.

Consultant Specification

Operation

The air temperation unit shall be a ComfoClime 24 manufactured by Zehnder and shall be suitable to mount directly onto a ComfoAir Q350 or Q450 supply and extract unit mounted onto a floor stand in accordance with the specification.

The air temperation unit shall remove heat energy and moisture from the supply air in the summer. The heat energy shall be transferred from the supply air to the exhaust air and directed to outside via the ComfoAir Q350 or Q450 system with enthalpy cube. In the winter the unit shall provide supplementary heating to the supply air. The units shall not require external units but instead only rely on the intake and exhaust terminations of the ComfoAir Q350 or Q450 unit. The dehumidification of the air creates condensation which shall be drained to the waste water system.

The air temperation unit shall have the ability to activate or deactivate automatically based on the selected temperature profile with the ability to automatically increase the ventilation rate if required. The air temperation option shall only activate automatically in summer and automatically disable during the winter months, with the heated air option automatically activated in winter and disabled during the summer. The supply and extract ventilation unit shall be a ComfoAir Q manufactured by Zehnder and shall be suitable to mount on a floor stand, wall or in a cupboard in accordance with the specification.

The fresh filtered air from outside shall be supplied to each of the habitable rooms and pre-heated by the warm extract air from the wet areas, such as kitchen or bathroom, via the plastic counter flow heat exchanger. The ventilation unit shall vary its speed of the EC motors automatically when it receives a signal from one of the inbuilt sensors or via external switches.

Controls

The ComfoClime unit shall contain the following functions within the unit pre-wired and factory fitted by the manufacturer:

- Temperature sensors to monitor internal and external conditions in addition to the supply air to determine when to activate

All ComfoAir Q units shall contain the following functions within the unit pre-wired and factory fitted by the manufacturer:

- Dial-a-duty motor control
- 4 Variable speed flow rate set points
- Automatic filtered modulating summer bypass with timed manual override option
- Heat exchanger frost protection
- Commissioning wizard to enable commissioning of the unit
- Integral service, fault and operation indicators
- Control panel PIN protection
- Tool free filter access
- Humidity sensors to operate the unit in response to humidity spikes above natural background humidity levels as opposed to a single threshold humidity point to activate the high set point
- Automatic passive boost for night time cooling
- Variable overrun timer relative to high speed activation period

All ComfoAir Q units shall contain the following options when combined with relevant ancillaries:

- BMS compatibility via KNX / Modbus protocol option (ComfoConnect KNX C / ComfoConnect PRO)
- Wi-Fi connectivity option (ComfoConnect PRO)
- RFZ wireless connectivity option (RF-PCB or ComfoSense C 67)
- Switched live input option (Option Box V2 Lite)
- Volt free contact option (Option Box V2 Lite)
- 0-10V input option (Option Box V2 Lite)
- Pre-heater frost protection option
- Post-heater control option (Option Box V2 Lite)
- Control input for single or multiple capacitive touch speed controllers with 7 day programmer capabilities (ComfoSense C 67)
- Control input for single or multiple 4 speed manual/auto controller with filter alert (ComfoSwitch C 67)
- Control input for single or multiple CO2 sensors with combined 3 speed manual controller (CO2 sensor C67)