

Translation of the original instruction manual

Heat Recovery Unit CLIMOS F 200



Legal regulations

All rights reserved.

This instruction manual has been compiled with the utmost care. Nevertheless, the publisher accepts no liability for damage caused by missing or incorrect details in this instruction manual. We reserve the right at any time and without previous notification to change the content of this manual in part or as a whole.

The information contained in these documents is the property of Zehnder Group. Any form of publication, whether in whole or in part, requires the written approval of Zehnder Group. In-house duplication, designated for the evaluation of the product or for proper use, is permitted and not subject to approval.

Trademarks

All trademarks are recognised, even if they are not separately labelled. A missing label does not mean that an article or sign is free of trademark rights.

Contents

1	Introduction	5
1.1	General	5
1.2	Validity	5
1.3	Target groups	5
1.3.1	Qualification of target group	5
1.3.1.1	Users.....	5
1.3.1.2	Qualified personnel	5
1.4	Conformity.....	5
2	Proper use	6
2.1	Operation of the unit.....	6
2.2	Intended use	6
2.3	Provisions for operation with fireplaces.....	6
2.4	Guarantee conditions, warranty and liability.....	6
2.4.1	Guarantee conditions	6
2.4.2	Warranty	6
2.4.3	Liability.....	7
3	Safety	7
3.1.1	Symbols used	7
3.1.2	Safety regulations	7
3.1.2.1	Safety instructions – general.....	7
3.1.2.2	Safety instructions – Installation.....	8
3.1.3	Installation conditions.....	8
4	Chapter for operators and qualified personnel	8
4.1	Product description	8
4.1.1	Control panels.....	9
4.1.2	Main components.....	9
4.1.3	Type label	9
4.1.4	Frost protection	9
4.2	Available control modules	10
4.2.1	LED control panel.....	10
4.2.1.1	LED control panel control functions.....	10
4.2.1.2	Signals used to indicate operating and error conditions.....	12
4.2.2	TFT control panel.....	12
4.2.2.1	TFT control panel operations and signals.....	13
4.3	Menu structure of the TFT control panel	15
4.3.1	Main menu Information	15
4.3.1.1	Sub-menu Current message.....	15
4.3.1.2	Sub-menu Last message	16
4.3.1.3	Sub-menu Fan speeds.....	16
4.3.1.4	Sub-menu Current device status.....	16
4.3.1.5	Sub-menu Software versions	16
4.3.1.6	Sub-menu Connected units.....	16
4.3.1.7	Sub-menu Filter running time.....	16
4.3.1.8	Sub-menu Operating hours.....	16
4.3.2	Main menu Settings	16
4.3.2.1	Sub-menu Fan speeds.....	16
4.3.2.2	Sub-menu Filter	16
4.3.2.3	Sub-menu Frost protection.....	17
4.3.2.4	Sub-menu Automatic.....	17
4.3.2.4.1	Automatic timer	17
4.3.2.4.2	Automatic sensor	19
4.3.2.5	Sub-menu Date/time	19
4.3.2.6	Sub-menu Language selection	19
4.3.2.7	Sub-menu Screen dimming.....	19
4.3.2.8	Sub-menu Key lock.....	20
4.3.2.9	Sub-menu Summer ventilation without bypass	20
4.3.2.10	Sub-menu Supply heater	20
4.3.2.11	Sub-menu Ground heat exchanger shutter	20
4.3.2.12	Sub-menu Brine defroster cooling.....	21
4.3.3	Boost ventilation mode with external boost ventilation actuator	21
4.4	Maintenance by the user	21
4.4.1	Replacing the unit filters.....	21
4.4.2	Resetting the filter running time	23
4.4.2.1	Reset filter running time with LED control panel	23
4.4.2.2	Reset filter running time with TFT control panel.....	24

4.4.3	What should I do in case of a fault?.....	24
4.5	Disposal.....	24
5	Chapter for qualified personnel.....	25
5.1	General system configuration.....	25
5.2	Installation requirements.....	25
5.2.1	Transport and packaging.....	25
5.2.2	Checking the scope of delivery.....	26
5.3	Mounting.....	26
5.3.1	Installation preparations.....	26
5.3.2	Installation position: suspended from the ceiling.....	27
5.3.3	Installation position: reclined.....	27
5.3.4	Installation position: mounted horizontally on the wall.....	27
5.3.5	Installation position: mounted vertically on the wall.....	28
5.3.6	Installation position: mounted horizontally on the wall slope.....	28
5.3.7	Installation position: mounted vertically on the wall slope.....	29
5.3.8	Connecting the ventilation tubes.....	29
5.4	Electrical connections.....	30
5.4.1	Adapter board connection.....	31
5.4.2	Connecting TFT control panel.....	31
5.4.3	Connecting several TFT control panels.....	32
5.4.4	Connecting the LED control panel.....	32
5.4.5	Connecting external actuators/sensors to the Master Controller.....	33
5.4.5.1	Connecting external boost ventilation keys.....	37
5.4.5.2	Connecting external sensors.....	37
5.4.5.3	Connecting the status relay.....	37
5.4.5.4	Connecting external release.....	37
5.4.5.5	Connecting digital inputs and outputs.....	38
5.4.6	Operation without connected control panel.....	38
5.5	Commissioning.....	38
5.5.1	Readiness for operation.....	38
5.5.2	Adjusting the air volume flow.....	38
5.5.2.1	Adjusting the nominal air volume flow with TFT control panel.....	38
5.5.2.2	Adjusting the nominal air volume flow with LED control panel.....	39
5.5.3	Adjusting the valves.....	40
5.6	Menu settings by qualified persons/service staff.....	40
5.6.1	Main menu Setup.....	40
5.6.1.1	Sub-menu Frost protection.....	40
5.6.1.2	Sub-menu Fan speeds.....	41
5.6.1.3	Sub-menu Supply heater.....	41
5.6.1.4	Sub-menu Summer ventilation without bypass.....	42
5.6.1.5	Sub-menu Ground heat exchanger shutter.....	42
5.6.1.6	Sub-menu Reset to factory data.....	43
5.7	Service and maintenance.....	43
5.7.1	Inspection and cleaning of the heat exchanger.....	43
5.8	Error display and troubleshooting.....	47
5.8.1	Error display with LED control panel.....	47
5.8.2	Error displays with TFT control panel.....	48
5.9	Technical description.....	48
5.9.1	Type versions.....	48
5.9.2	Air connections of the versions.....	48
5.9.3	Technical specification.....	49
5.9.4	Dimensions.....	51
5.9.5	Circuit diagram CLIMOS Basic series.....	52
5.9.6	Circuit diagram CLIMOS Comfort series.....	53
5.9.7	Master Controller terminal assignment.....	54
6	Appendices.....	55
6.1	Checklist A Maintenance work for users.....	55
6.2	Checklist B Maintenance work for qualified personnel.....	56
6.3	Commissioning and handover protocol.....	57
6.4	Air volume protocol.....	58

1 Introduction

1.1 General

This translation of the original instruction manual contains instructions and information on the safe operation, correct installation, operation and maintenance of the Climos F 200 ventilation unit.

Subject to change and all rights reserved.

This documentation has been compiled with the utmost care. However, no rights can be derived from this regarding the publisher's liability for damages due to missing or incorrect information in this documentation. As a result, it is possible that the unit may deviate slightly from this description. In the event of disputes, the German version of the documentation shall be binding.

- Read the instructions in full before installing and commissioning the ventilation unit. This will help you avoid hazards and errors.
- Be sure to observe all safety notes, warnings and information on precautionary measures.
- The instruction manual constitutes a part of the product. Keep the manual for future reference.

! Questions

You can address all questions and request the most recent manuals and new filters from your Zehnder representative. The contact information is found on the back cover of this manual.

1.2 Validity

This document applies to:

- CLIMOS F 200 Basic series (Zehnder Climos 200 enthalpy series)
- CLIMOS F 200 Comfort series (Zehnder Climos 200 V enthalpy series)

All the units in the CLIMOS F 200 Basic series and CLIMOS F 200 Comfort series are referred to below using the generic product name CLIMOS, except where it is necessary to distinguish between specific types.

This instruction manual deals with the various design variants of the CLIMOS ventilation unit. Possible accessories are only described to the extent necessary for appropriate operation of the unit. Please refer to the respective instructions for further information on accessory parts.

1.3 Target groups

This instruction manual is for users and qualified personnel. The activities are only allowed to be carried out by appropriately trained personnel who are sufficiently qualified for the respective work involved.

1.3.1 Qualification of target group

1.3.1.1 Users

Users must be instructed by qualified personnel as follows:

- Instruction in hazards when handling electrical devices.
- Instruction in the operation of the CLIMOS unit.
- Instruction in the maintenance of the CLIMOS unit.
- Knowledge of and compliance with this manual, including all safety instructions.

1.3.1.2 Qualified personnel

Qualified personnel must have the following qualifications:

- Training in dealing with hazards and risks when installing and operating electrical devices.
- Training for the installation and commissioning of electrical devices.
- Knowledge of and compliance with the locally applicable building, safety and installation regulations of the relevant local authorities or municipalities, the regulations of the water and electric utilities and other official regulations and guidelines.
- Knowledge of and compliance with this document, including all safety instructions.

1.4 Conformity

The Climos F 200 series ventilation units from the manufacturer



Zehnder Group Zwolle B.V.

Lingenstraat 2 • 8028 • PM Zwolle-NL • Tel.: +31 (0)38-4296911

Zwolle commercial register 05022293

comply with the directives and standards of the EU and EAC Declaration of Conformity.

2 Proper use

2.1 Operation of the unit

- The unit may only be operated if it has been installed correctly and according to the specifications and directives of the installation manual of the unit.
- The unit may be operated by the following groups of people: children from age 8, persons with limited physical, sensory or mental abilities, or persons with insufficient experience and specialised knowledge, provided they are supervised or instructed in the safe handling of the unit and understand the associated hazards.
- Children must not play with the unit.
- Children must not carry out cleaning and maintenance without supervision.

2.2 Intended use

- The CLIMOS unit can be used for controlled ventilation in homes and offices (and in industrial buildings subject to certain restrictions), in which no exceptional humidity loads occur. The air humidity of the ventilated rooms may not permanently exceed 70% RH, short term increased humidity of 80% RH for approximately one hour is permissible. Any other use or any use beyond this is considered improper use.
- The ventilation unit is not suitable for smoke extraction or drying buildings, for ventilation of rooms with aggressive and corrosive gases or for rooms with extreme dust levels.
- The unit must not be used for extracting combustible or explosive gases.
- Intended use also includes observing all instructions in the instruction manual.

In the event of improper use, the Zehnder Group accepts no liability for any damage that may occur and no warranty for the proper and functional operation of the ventilation unit.

2.3 Provisions for operation with fireplaces

Local requirements must be taken into account through appropriate standards, laws and guidelines. The CLIMOS unit may only be installed in rooms, apartments or utilisation units of comparable size in which open flue fireplaces are installed if:

- safety features prevent simultaneous operation of open flue fireplaces and the air extracting system or
- the flue gas discharge of the open flue fireplace is monitored by special safety features. In case of open flue fireplaces for liquid or gaseous fuels, the fireplace or the ventilation system must be switched off if the safety feature is triggered. In case of open flue fireplaces for solid fuels, the ventilation system must be switched off if the safety feature is triggered.
- The CLIMOS is prepared for the simultaneous operation with fireplaces.

The ventilation units for controlled ventilation of an apartment or comparable utilisation unit must not be installed if open flue fireplaces are connected to multiple-occupancy flue systems in the utilisation unit.

For proper operation, it must be possible to shut off any combustion ventilation lines and flue gas systems of open flue fireplaces. In case of flue gas systems of fireplaces for solid fuels, it must only be possible to operate the cut-off device manually. The position of the cut-off device must be recognisable from the setting of the operating handle. This is considered to be fulfilled if a cut-off device against soot (soot blocker) is used. Fire protection requirements with regard to the fire protection installation regulations for the construction of the ventilation system, and federal state regulations, in particular the building authority guideline on the fire protection requirements for ventilation systems in the currently valid version, must be observed.

2.4 Guarantee conditions, warranty and liability

2.4.1 Guarantee conditions

The manufacturer gives a warranty of 24 months starting from the installation date, or a maximum 30 months starting from the date of manufacture, for the unit. Warranty claims may only be asserted for material defects and/or design faults that have occurred during the warranty period.

In the event of a warranty claim, the unit must not be disassembled without the written consent of the manufacturer. Spare parts are only covered by the warranty if they have been supplied by the manufacturer and fitted by an approved technician.

2.4.2 Warranty

In the event of a warranty claim, the unit must not be disassembled without the written consent of the manufacturer. Spare parts are only covered by the warranty if they have been supplied by the manufacturer and fitted by an approved technician.

The warranty shall be null and void if:

- The warranty period has elapsed.
- The installation has not been carried out in accordance with the applicable regulations.
- The unit is operated without a filter.
- Original parts have been replaced by non-original parts.
- Unauthorised changes or modifications to the unit have been made.
- The defects are due to improper installation, improper use or neglected maintenance of the system.

2.4.3 Liability

The CLIMOS is intended for use in the mechanical ventilation of apartments, offices and rooms with a similar purpose. Every other use other than that described in chapter 2 is considered “improper use” and may result in personal injury or damage to the balanced ventilation unit for which the manufacturer cannot be held liable.

The liability of the manufacturer becomes null and void in the following cases:



- Failure to observe the instructions specified in this manual pertaining to safety, operation and maintenance.
- Modifications to the ventilation unit or the use of components that have not been approved or recommended by the manufacturer.
- Incorrect installation, improper use or contamination of the system.
- Original parts have been replaced by non-original parts.
- The unit is operated without a filter.

3 Safety

Carefully read all safety instructions prior to commissioning the unit to make sure that you use the unit in a safe and intended way.

3.1.1 Symbols used

You will find the following symbols in this document:

Symbol	Meaning
	Important note!
	Caution: Risk of affecting the operation of the ventilation system or damaging the unit!
	Caution: Risk of personal injury!

3.1.2 Safety regulations

3.1.2.1 Safety instructions – general

- Always observe the safety regulations, warning, comments and instructions stated in this manual. Non-observance results in hazard of injury and hazard of material damage to the CLIMOS.
- The installation, commissioning and maintenance (except for filter replacement) must be carried out by an approved technician unless stated otherwise in the instructions. Implementation of this work by a non-approved technician can result in personal damage or reduced performance capacity of the ventilation system.
- Do not disconnect the unit from the power supply unless instructions to the contrary are listed in the manual. This can result in the formation of moisture and mould.
- Do not make any changes to the unit or to the specifications listed in this document. Such changes can cause personal injury or lead to reduced performance of the ventilation system.
- To prevent accidents, a damaged mains cable must be replaced by an original cable by the manufacturer, a person commissioned to carry out maintenance by the manufacturer or a similarly qualified person.
- After installation, have your system engineer/installer instruct you on the unit and the control panel. The ventilation unit may only be used in accordance with chapter 2 "Intended Use".
- Only operate the unit with a closed housing.

3.1.2.2 Safety instructions – Installation

- Comply with the general locally applicable building, fire, safety and installation regulations of the relevant local authorities, the regulations of the water and electric utilities and all other official regulations.
- Pull the unit's plug from the mains socket to separate the unit from the power supply. If the unit does not have a plug, use a switch according to EN 60335-1 (with separation of all three poles and 3 mm clearance, over-voltage category III).
- Always disconnect the unit from the power supply prior to commencing maintenance or repair activities. If the CLIMOS unit is operated while open, there is hazard of injury.
- Make sure that the CLIMOS unit cannot switch on unintentionally.
- To eliminate the risk of coming into contact with the running fans, the air ducts must be fastened to the unit before the power supply is connected, observing a minimum length of 900 mm.
- Therefore, always apply measures to prevent electrostatic discharges when working on the electronics. Wear an antistatic wrist band, for example. Static energy can cause damage to electronic components.
- The entire installation must comply with the applicable (safety) regulations from the following sources:
 - local EU standard for safety features for low voltage systems;
 - Mounting/installation manual of the manufacturer (see the back cover of the instruction manual for the contact data of Zehnder).
- A socket with grounding at a distance of 1 meter or no more than the length of the included mains cable must be present.
- Always use the included mains cable.
- For safety reasons do not use an extension cable.

3.1.3 Installation conditions

The following conditions must be considered when deciding whether a unit should be installed in a specific area to ensure the correct installation of the unit.

- Ensure that the temperatures in the installation area are in the permissible range year-round. The information regarding the permissible temperature can be found in the "Technical specification" table.
- When choosing an installation location, it is recommended that you avoid areas with a high average level of humidity (ambient conditions for indoor climate control system must not continuously exceed 70% RH at 22 °C).
- The unit must not be installed in rooms subject to explosion hazards.
- Inside wet rooms, the unit may only be installed outside of protection zones 1 and 2 in accordance with DIN 57100/VDE 100 Part 701.
- Connect the unit to a power source with 230 V/50 Hz.
- Check whether the electrical installation is suitable for the maximum output of the unit. The values for the electrical input power can be found in the "Technical specification" chapter.
- Check that the installation area of the unit meets the requirements in the "Installation requirements" chapter.

4 Chapter for operators and qualified personnel

4.1 Product description

The CLIMOS unit is a ventilation unit with heat recovery for healthy, well-balanced and energy-saving comfort ventilation. A comfort ventilation system extracts foul-smelling waste air from areas such as kitchens, bathrooms and toilets and conveys an identical quantity of fresh air into living rooms, bedrooms and children's rooms.

A membrane moisture heat exchanger (enthalpy exchanger), which can transfer both humidity and heat owing to its physical characteristics, is used in the CLIMOS unit for the waste heat recovery. We recommend the use of humidity sensors for monitoring the limits in rooms with high humidity.

The housing is made from sheet metal with an anthracite powder coating. The high-quality polypropylene inner lining ensures the necessary thermal insulation and unit soundproofing.

The CLIMOS Comfort version is distinguished from the CLIMOS Basic version by an integrated defroster heating. Both versions are available in the types R (right – type A), or L (left – type B). The type label includes information about the version and type of the unit.

The CLIMOS unit has two maintenance-free 230 VAC centrifugal fans with an integrated power supply unit and electronic commutation. The fans run at a steady volume flow to keep the air volume constant at any selected fan

speed. The air volume is not affected even if the filters become soiled. The unit contains filters according to EN ISO 16890 of the filter class ISO Coarse for the outdoor air and the extract air. These consist of a synthetic non-woven filter medium with a polypropylene frame. As an option, filters of filter class ISO ePM1 can be used for the outdoor air.

4.1.1 Control panels

With the TFT control panel or LED control panel you can configure and operate the system from a central point. Both control panels are only suitable for use in indoor areas.

4.1.2 Main components

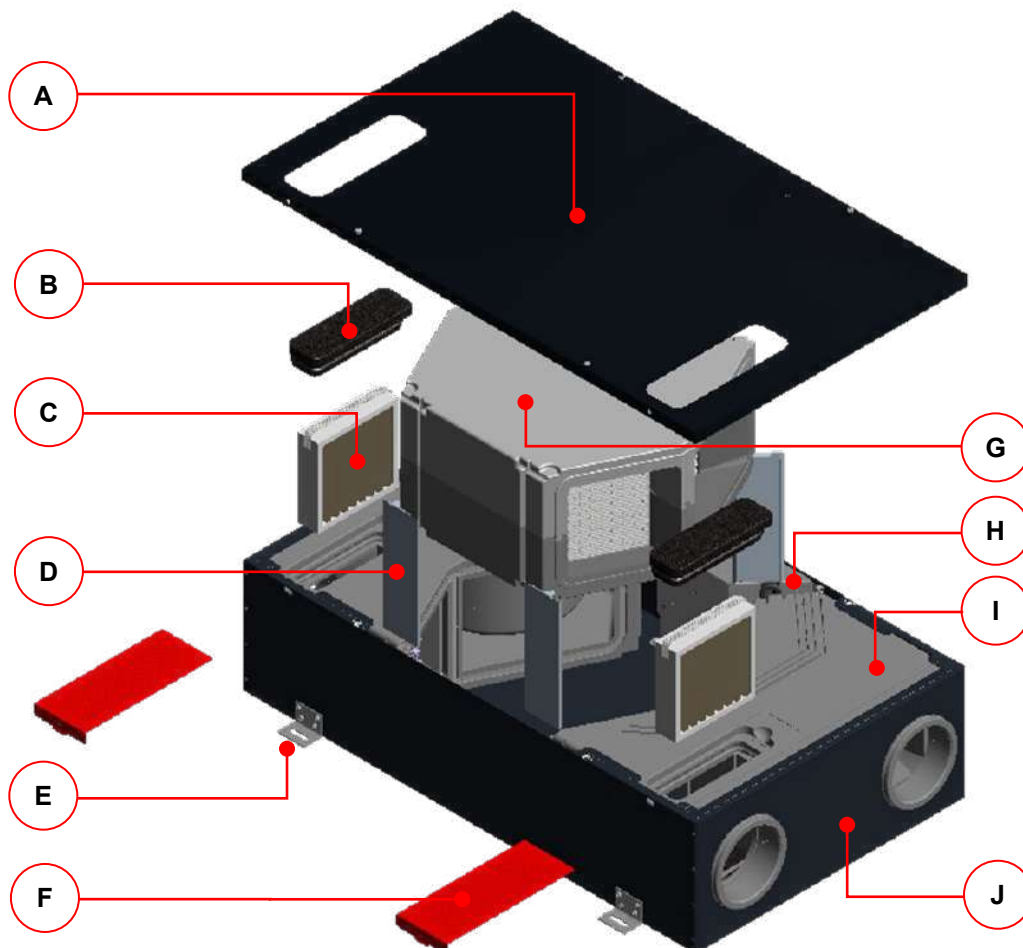

Fig. 1: Main components of the CLIMOS ventilation unit

Item	Description
A	Casing lid with quarter-turn lock (4x)
B	EPP filter cover (2x)
C	Filter (2x)
D	Holding clamp (4x)
E	Mounting bracket (4x)
F	Design filter cover (2x), optional
G	Heat exchanger box
H	Unit control
I	Fan box (2x)
J	Housing

Table 1: CLIMOS main components

4.1.3 Type label

The type label identifies the product unequivocally. The type label is found on the housing side next to the electrical connections. You will need the details on the type label for the safe use of the product and in case of questions for service. The type label must be attached permanently on the product.

4.1.4 Frost protection

The CLIMOS unit is equipped with automatic frost protection, which prevents the heat exchanger from freezing

should the outdoor air temperature drop to a very low level. Depending on the set frost protection mode, if the outdoor air temperature drops below a certain limit, the fans are temporarily shut off. In CLIMOS Comfort series with integrated defroster, if the temperature drops below the outdoor air temperature limit, a PTC heating register is activated. If, despite the heat introduced by the integrated defroster, the temperature falls below the limit, the fans are also temporarily switched off.

The automatic frost protection for screening the supply air temperature protects an optional downstream hydraulic heat register from freezing and temporarily switches off the fans if the supply air of the fans drops below a certain limit.

4.2 Available control modules

The CLIMOS unit can be operated with the following control modules:

- Control unit LED control panel with the PEHA switch programme design (W x H x D in mm: 80 x 80 x 12)
- Control unit TFT control panel (W x H x D in mm: 102 x 78 x 14)
- External boost ventilation key(s) (as many as required, potential-free)
- External sensors with sensor signal 0–10 V or 4–20 mA

4.2.1 LED control panel

The LED control panel is equipped with 7 symbolised short-stroke keys. Pushing a key or a key combination triggers the associated control functions. The active operating mode is indicated in each operating field via a green or red LED. The LED control panel with the PEHA switch programme design can be installed on the surface or in the wall. In case of surface-mounted installation a PEHA surface-mounted plug socket is needed.

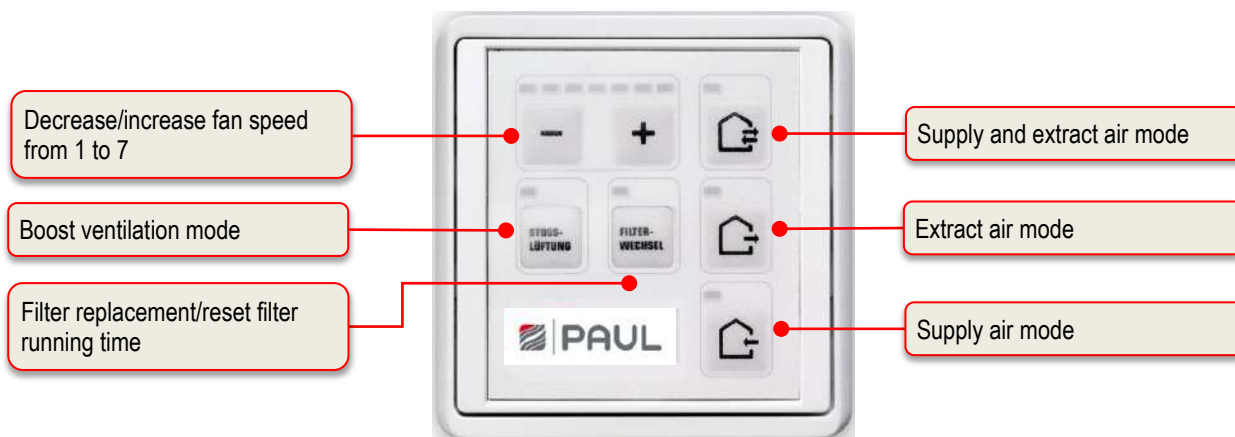

Fig. 2: Operation and information fields LED control panel

4.2.1.1 LED control panel control functions

Symbol	Description	Explanation
	Key Supply and extract air mode	Pushing this key sets the supply and extract air mode.
	Key Extract air mode	Pushing this key sets the extract air mode only. The supply air mode is switched off. This key must be permanently deactivated when operating the ventilation unit with a fireplace! Simultaneous operation of a ventilation system and fireplace imposes more stringent safety requirements with regard to <u>low pressure screening</u> and a switch-off function is required for the ventilation unit.
	Key Supply air mode	Pushing this key sets the supply air mode only. The extract air mode is switched off.
	Key Decreasing the fan speed	Pushing this key decreases the fan speed in increments.
	Key Increase fan speed	Pushing this key increases the fan speed in increments.
	Key Boost ventilation mode	Pushing this key activates the boost ventilation during the supply and extract air mode on fan speed 7 for 15 minutes. At the end of the boost ventilation time the previously active operating mode resumes. You can cancel the boost ventilation mode at any time by

















			pressing another function key.
	Key Reset filter running time		To ensure cyclic filter inspection, the control has an integrated operating hours counter. The reset filter running time key allows you to reset the filter running time.
 ... 	Key combination activate/deactivate standby mode		The standby function sets the ventilation unit to an energy saving mode. Repeated pushing of the – key until LED L1 is also turned off activates the standby mode. This status is indicated by the periodic flashing of LED L8. Pushing the + key ends the standby mode and sets fan speed 1. LED L1 is lit up.
 ... 	Key combination configuration mode for operation together with a fireplace		Pushing the key combination for at least 3 seconds deactivates the extract air mode permanently. This status is signalled by LEDs L8+L11+L12, where L8 and L12 are lit up, L11 blinks 2 times and then remains switched <u>off</u> . This signal is only visible when holding the key combination. Activating the extract air mode key in the deactivated state results in a short 3 time blinking of LED L11 to signal the deactivated state. Pushing the key combination again for at least 3 s cancels the key lock. This change is again signalled by the LEDs L8+L11+L12, where L8 and L12 are lit up, L11 blinks 2 times and then remains switched <u>on</u> . This signal is only visible when holding the key combination. This enables the extract air mode again.
			Always press the reset filter replacement key first!
 ... 	Key combination for the summer ventilation temperature limit configuration mode		The summer ventilation can only be implemented with an LED control panel if it has been released in the factory setting.
 ... 	Setting keys		Pushing the key combination for at least 3 seconds activates the setting for the temperature limit. This status is signalled by the blinking of LEDs L8 and L10. With the setting keys the upper temperature limit for summer ventilation depending on the extract air temperature can be set between 21 °C (LED L1 lights up) and 27 °C (LED L7 lights up). After pressing the key combination again for at least 3 s the setting is saved and the summer ventilation temperature limit is terminated.
			Always press the reset filter replacement key first!
 ... 	Key combination imbalance configuration mode		By pushing the key combination for at least 3s, the imbalance configuration mode is activated and the LEDs L10 and L12 blink. The keys for setting the balance can now be used to set the balance of the fan speeds active upon activation of the imbalance configuration mode in 5% increments. The balance is not set for each fan speed individually, but jointly for a group of fan speeds. The adjustable range is between -15% (L1) and +15% (L7). In the central position (L4) the supply air and extract air run with the same rotational speed. After pressing the key combination again, the setting is saved and the imbalance configuration mode concluded.
 ... 	Keys for setting the balance		
	1st group fan speeds <1+2>		
	2nd group fan speeds < 3 +4+5>		Always press the reset filter replacement key first!
	3rd group fan speeds <6+7>		

Table 2: LED control panel control functions

4.2.1.2 Signals used to indicate operating and error conditions

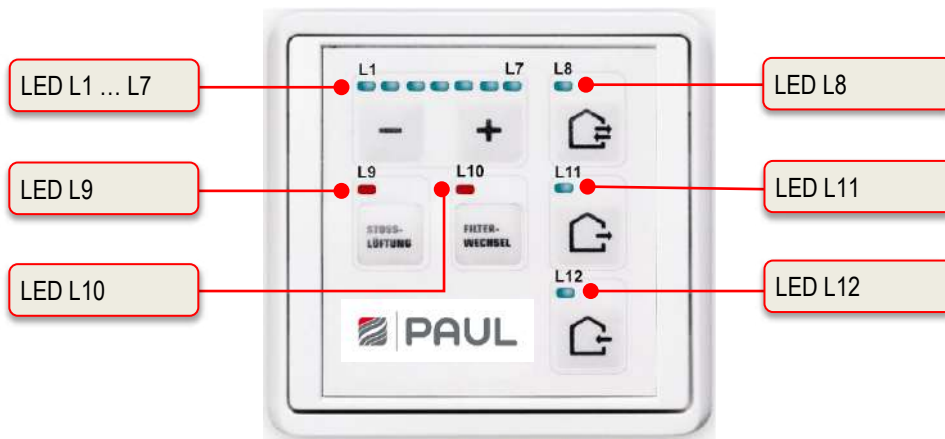

Fig. 3: LED signals LED control panel

LED signal	Function / Meaning
LED light strip display L1 ... L7	No LED \triangleq fan speed 0 (fan off, standby) 1 LED (L1) \triangleq fan speed 1 2 LEDs (L1 + L2) \triangleq fan speed 2 ... etc. 7 LEDs (L1+ L2+...+ L7) \triangleq fan speed 7
L1 + L7 light up	No external release: fan is off
L8 lights up	Supply and extract air mode
L8 blinks	Error (sensor or frost protection (outdoor air temperature too low)): Fans are switched off
L8 flashes	Standby mode active
L8 + L10 blink	Summer ventilation temperature limit configuration mode (Displayed only during the configuration phase)
L8+ L11 + L12 blink	General error, the error number is displayed binary with LEDs L1 to L7, see (Table 38 in chapter 5.8.1 Error signals with LED control panel)
L8 + L12 light up + L11 blinks 2x and then stays out	Configuration mode for operation together with a fireplace (Displayed only during the configuration phase)
L9 lights up	Boost ventilation mode (L1 + L2 + L3 + L4 + L5 + L6 + L7 light up)
L10 lights up	Filter running time expired
L10 flashes	The remaining filter running time is \leq 10 days
L10 + L12 blink	Configuration mode balance compensation for the selected fan speed (Displayed only during the configuration phase)
L11 lights up	Extract air mode
L11 blinks	Error fan 1 HALL: Fans are switched off
L11 blinks briefly 3 times	Extract air mode deactivated (extract air mode key locked, configuration for operation in conjunction with fireplace active)
L12 lights up	Supply air mode
L12 blinks	Error fan 2 HALL: Fans are switched off

Table 3: Functions assigned to LED signals

4.2.2 TFT control panel

The 3.5" TFT display of the control panel is operated by touching the button symbols with the fingers. The active operating mode and the associated button are indicated by colour signals. The control panel can be fitted into a standard flush socket.



The ventilation unit can be operated with up to three TFT control panels or without a control panel. In this case, the system operates in the last set operational mode.

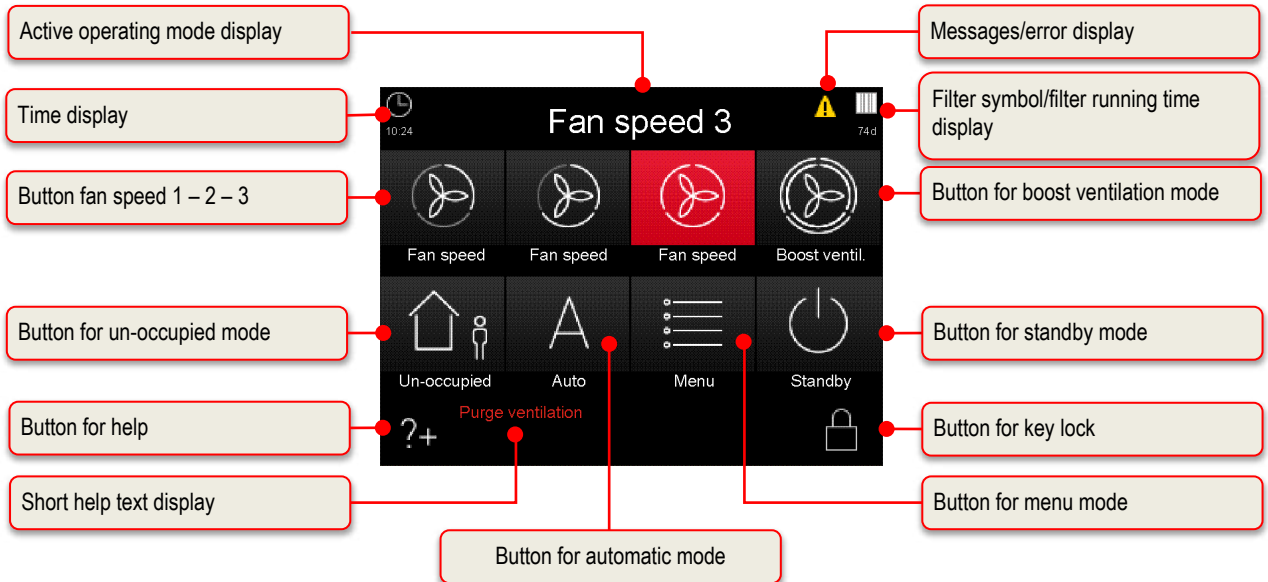

Fig. 4: Operation and information fields of the touch pad

4.2.2.1 TFT control panel operations and signals

Symbol	Description	Explanation
-	Fan speed 0 (FS0)	The fans come to a stop. This fan speed is used for the functions automatic timer mode and un-occupied mode
	Button Fan speed 1 (FS1)	By touching this button, the smallest permanent fan speed 1 (reduced ventilation) is set.
	Button Fan speed 2 (FS2)	By touching this button, the medium permanent fan speed 2 (nominal ventilation) is set. This fan speed is set by the service technician during the commissioning of the unit. A balance between supply air and extract air is adjusted.
	Button Fan speed 3 (FS3)	By touching this button, the highest permanent fan speed 3 (intensive ventilation) is set.
	Button Boost ventilation mode	Touching this button sets the boost ventilation mode. It initiates an automatic timer programme in which the fan speed 3 is active for a duration of 15 minutes (factory setting).
	Button Un-occupied mode	Pushing this button sets the un-occupied mode. For the duration of an absence, activating the un-occupied mode sets a reduced ventilation intensity for moisture protection. A different button must be activated to end this function.
	Button Automatic mode	The automatic mode has 2 automatic functions – automatic timer and automatic sensor, in which the manual settings are deactivated upon touch.
	Automatic timer mode	With the automatic timer mode, different fan speeds (FS0, FS1, FS2 or FS3) can be stored for every day of the week with a duration of 15 minutes. This “fan speed weekly profile” can be configured and individually adjusted in the menu settings/sub-menu automatic timer.
	Automatic sensor mode	The automatic sensor mode controls the fan according to a pre-set linear characteristic curve depending on an analogue room air quality sensor (also a combination of CO ₂ , air humidity and temperature).
	Button Menu mode	By touching this button, you enter the Information, Settings and Set-up menu.











	Button Standby mode	The standby function sets the ventilation unit to an energy saving mode. In the standby mode the total power consumption of the unit drops to less than 1 W. The screen display becomes dark, but the touch pad remains active for “waking” the system. Touching the touch pad is enough to end the standby mode.
	Button Help	By touching this button, you enter a context-sensitive help menu. If this key is grey, then there is no help text available.
	Button Activate key lock	By touching this button, the touch pad is deactivated except for this button. The screen is dimmed and inactive (cleaning status).
	Button Deactivate key lock	By touching and holding this button (approx. 2-3 s) you return to the start menu.
	Button Check mark	By touching this button, the desired or available parameter is selected or confirmed.
	Button Enter	By touching this button, you can navigate in the various sub-menus. Changed parameters are saved to the storage.
	Button Cancel/return	By touching this button, you move from a menu to the next higher menu level without saving and changed data.
	Signal Messages	A blinking yellow warning triangle on the top of the right side indicates an information or an error. Information is registered in the Information/Current message menu and errors in the Information/latest messages menu.
	Signal Filter symbol/filter running time	To ensure cyclic filter inspection, the control has an integrated operating hours counter. The operating time is subtracted in a count-down manner from the pre-set filter running time and indicated in days under the filter symbol. The filter symbol colour changes from white to yellow, when the filter running time ≤ 10 d and from yellow to red if the filter running time has expired. When the filter runtime is expired the message “replace filter” is created.
	Buttons + / -	By touching the button, you can change the menu values (e.g. fan speeds in 1% increments or the time in minute or hour increments).  The data is only saved when the enter button is touched!
	Buttons Navigation	By touching the navigation buttons left/right and up/down you can navigate in the menus to select the desired parameter in the respective menu level. If several values can be adjusted in a menu (e.g. for date and time: day, month, year, hours, minutes) you can select the individual values to be adjusted and then change them via +/-.

Table 4: TFT control panel operations and signals

4.3 Menu structure of the TFT control panel

The menu structure consists of the start menu and the three main menus (Information, Settings and Setup). The start menu is shown upon activation of the TFT touch pad. The main menus are each divided into sub-menus that allow access to information or parameter changes.

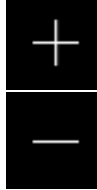
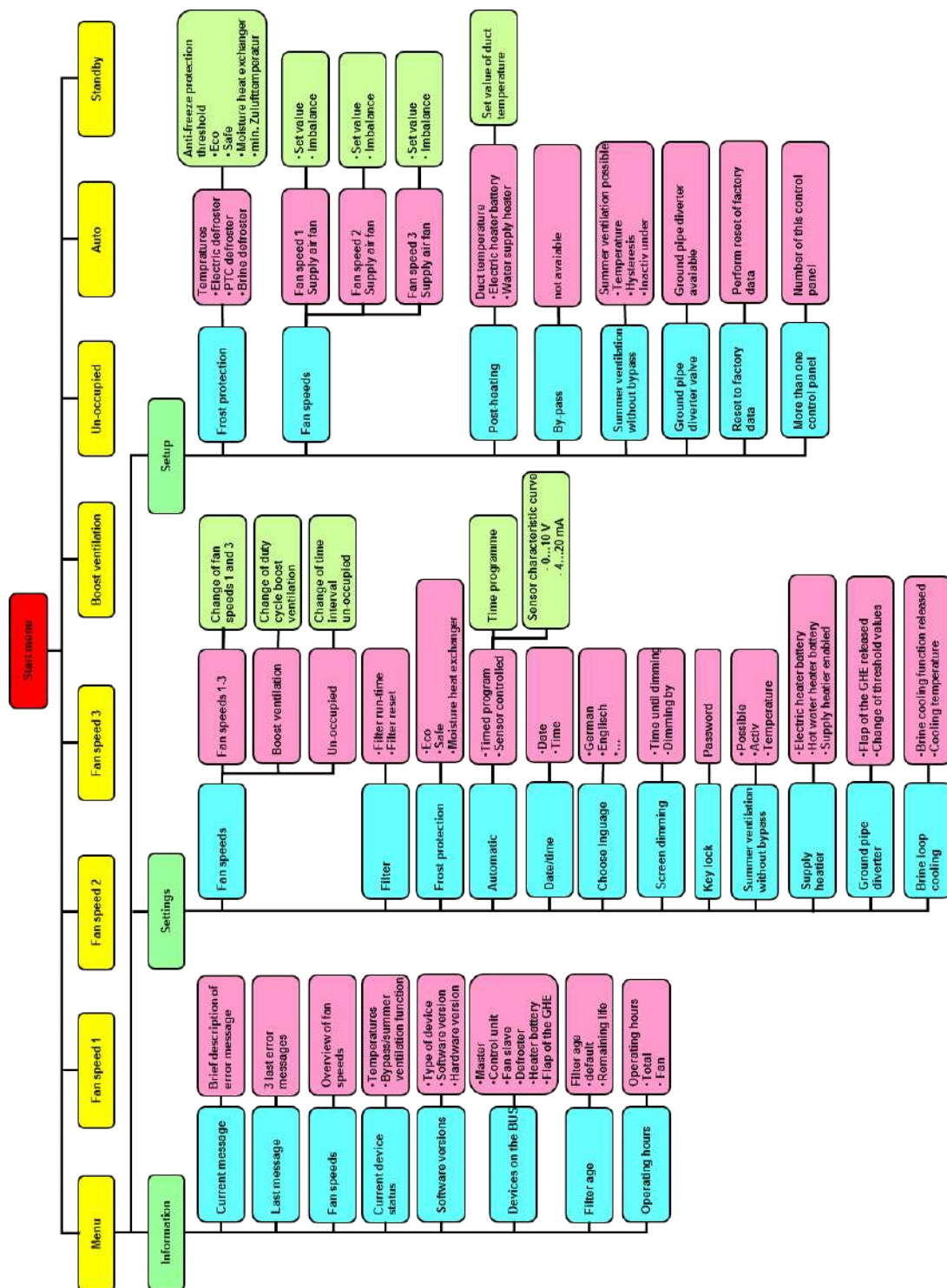

Fig. 5: Menu structure of the TFT control panel

4.3.1 Main menu Information

The main menu **Information** is divided into eight sub-menus. In the sub-menus information regarding the current unit status as well as selected factory settings (e.g. unit type) are displayed. The respective sub-menus are selected with the navigation buttons and opened via Enter.

4.3.1.1 Sub-menu Current message

In this sub-menu, information (e.g. replace filter) or errors (e.g. sensor disruption) are shown as current messages. In addition to this message, a yellow warning triangle blinks on the top right edge of the screen. In general, only error messages result in the shutting off of the fans.

4.3.1.2 Sub-menu Last message

This is where the last three occurred errors are registered with their date and time according to the event. In addition to this message, a yellow warning triangle blinks on the top right edge of the screen.

4.3.1.3 Sub-menu Fan speeds

In this sub-menu the percentage settings of the three fan speeds 1, 2 and 3 (FS1, FS2, and FS3) as well as the pre-set times for the un-occupied mode and boost ventilation mode are shown.

4.3.1.4 Sub-menu Current device status

In this sub-menu, the current unit-side supply air temperature and outdoor air temperature as well as the bypass status (closed/open) for units with bypass shutter or the summer ventilation status (active/inactive) for units without bypass shutter, are shown.

4.3.1.5 Sub-menu Software versions

In this sub-menu, the unit type along with the hardware and software status of the controllers included in the control system are shown.

4.3.1.6 Sub-menu Connected units

In this sub-menu check marks indicate which units are actually connected to the internal unit BUS and recognised by it.

4.3.1.7 Sub-menu Filter running time

In this sub-menu the pre-set filter running time and the current remaining filter running time are shown. The remaining filter-running time is counted down every calendar day of operation of the ventilation unit. In addition, when the pre-set filter running time is exceeded by more than 0 days, the message "Filter running time exceeded by xxx day", is shown.

4.3.1.8 Sub-menu Operating hours

The sub-menu shows:

- Total operating hours (time during which the unit is connected to the mains voltage)
- Fan operating hours (time in which the fans are operating)

4.3.2 Main menu Settings

In the main menu **Settings** users can make changes that primarily serve the individual adjustments that primarily serve adjustment to their individual comfort. The respective sub-menus are selected with the navigation buttons and opened via Enter. Only sub-menus with text shaded in red can be parametrised.



The settings in the sub-menus are only saved when the enter button is touched!

4.3.2.1 Sub-menu Fan speeds

The following can be selected and adjusted with the navigation buttons:

- Fan speed 1 and fan speed 3 (in 1% increments)
- Duration of the boost ventilation (in 5-minute increments)
- Fan intensity for un-occupied times (FS1 in min/h increments)





Symbol	Description	Explanation/Actions
	Button Fan speed 1 (FS1)	Activate FS1 with the button fan speed 1 and parametrise it with the navigation buttons. Setting range: 20% < FS1 < FS2
	Button Fan speed 3 (FS3)	Activate FS3 with the navigation button fan speed 3 and parametrise it with the navigation buttons. Setting range: FS2 < FS3 < 100%
	Permanent boost ventilation	Settings: 15 min ...120 min, the air volume flow of the boost ventilation is equal to fan speed 3.
	Fan intensity for the duration of the un-occupied time for moisture protection	Settings: 15 min/h, 30 min/h, 45 min/h, the ventilation intensity of the active time of the interval is equivalent to fan speed 1.

Table 5: Parametrisation sub-menu fan speeds

4.3.2.2 Sub-menu Filter

The following can be adjusted/read here:

- Filter running time in 10-day increments
- Current remaining filter running time
- Reset of the filter running time and the counter due to exceeding the filter running time



Symbol	Description	Explanation/Actions
	Duration of the filter running time	Settings: 30 d ... 180 d, with the navigation button a maximum filter running time of 90 days is recommended.
	Remaining filter running time	Display of the currently remaining filter running time
	Display area Resetting the filter running time	With the check mark and Enter buttons, the filter running time can be reset to the pre-set value.

Table 6: Parametrisation sub-menu filter

4.3.2.3 Sub-menu Frost protection

In this sub-menu the frost protection mode can be set with the navigation buttons:

- ECO
- Safe
- Moisture HE (enthalpy exchanger) with its own frost protection limit



Symbol	Description	Explanation/Actions
	Display area Frost protection mode ECO	In the "ECO" mode, a standard heat exchanger can freeze under extreme conditions. Not applicable for CLIMOS!
	Display area Frost protection mode Safe	In the "Safe" mode, freezing of the standard heat exchanger is generally prevented. Not applicable for CLIMOS!
	Display area Frost protection mode moisture heat exchanger	In the moisture HE mode, freezing of the enthalpy exchanger (membrane moisture heat exchanger) is generally prevented. For CLIMOS standard setting!

Table 7: Parametrisation sub-menu Frost Protection

4.3.2.4 Sub-menu Automatic

Two operating modes are available in the automatic mode:

- Automatic timer
- Automatic sensor

The desired operating mode of the automatic mode is selected with the navigation buttons (red text background) and setting a check mark and confirmed via Enter.

4.3.2.4.1 Automatic timer





Symbol	Description	Explanation/Actions
	Button Calendar	By touching, a weekday (Mon-Sun) or a group of weekdays (Mon-Fri, Sat-Sun) can be selected to allocate fan speeds to specific times.
	Button FS0	The fans come to a stop.
	Button FS1	Reduced ventilation
	Button FS2	Nominal ventilation
	Button FS3	Intensive ventilation
	Cursor	The cursor marks the time in the ¼-hourly range. With the navigation buttons the cursor is navigated over the time frame in which the selected fan speed should be active.

Table 8: Automatic timer parametrisation

By selecting a group of days (e.g. Mon-Fri), the changed data are applied to each day of the group. The settings for the group “Mon-Fri” are then identical for the days “Mon”, “Tue”, ... Fr (or for the group “Sat-Sun” identical for the days “Sat”, “Sun”). To operate the system with different fan speeds and time profiles on different days, the profile of the respective day (“Mon” ... “Sun”) must be changed. Any subsequent changes in the groups “Mon-Fri” or “Sat-Sun” will overwrite the previous settings of the individual days!

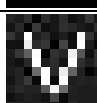
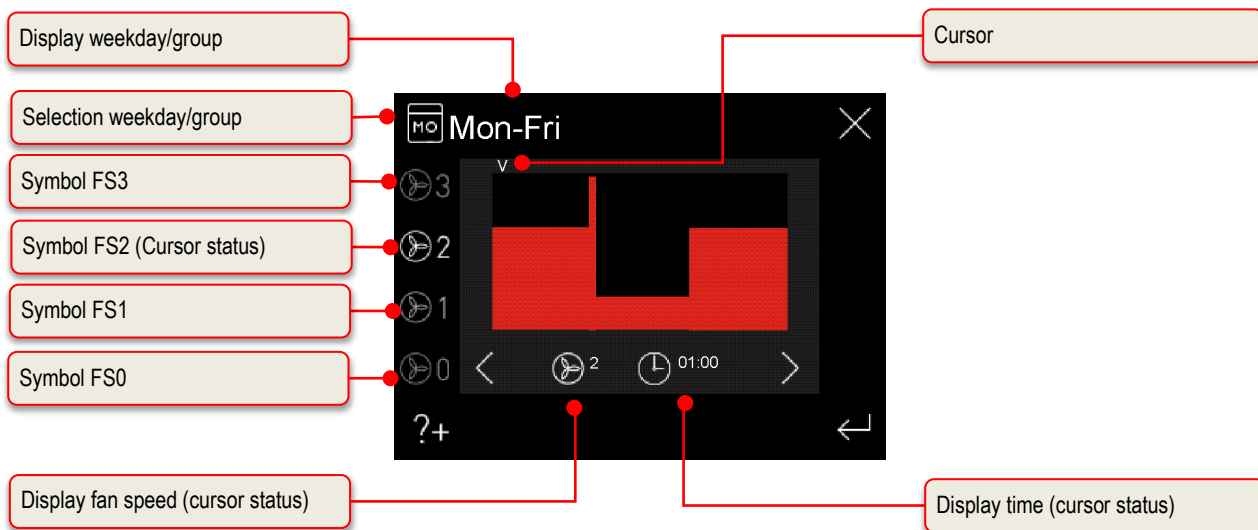

Fig. 6: Automatic timer factory setting, groups weekdays Mon-Fri

Fan speed	Time frame (Time 0 ⁰⁰ - 24 ⁰⁰)
FS1	8 ³⁰ - 16 ⁰⁰
FS2	0 ⁰⁰ - 8 ⁰⁰ 16 ⁰⁰ - 24 ⁰⁰
FS3	8 ⁰⁰ - 8 ³⁰

Table 9: Time frame factory setting, groups weekdays Mon-Fri

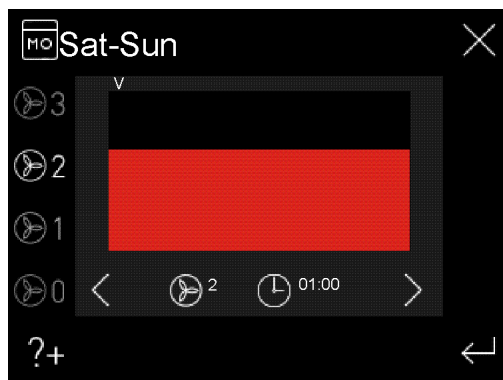



Fig. 7: Automatic timer factory setting, groups weekdays Mon-Fri

Fan speed	Time frame (Time 0 ⁰⁰ - 24 ⁰⁰)
FS2	0 ⁰⁰ - 24 ⁰⁰

Table 10: Time frame factory setting, groups weekdays Sat-Sun

 **The automatic timer factory setting can only be restored via the main menu Setup.**

If the operating mode “Automatic timer” is active in the automatic mode, then the active fan speed (only FS 1-3) is displayed in grey according to the time frame in addition to the automatic mode icon.

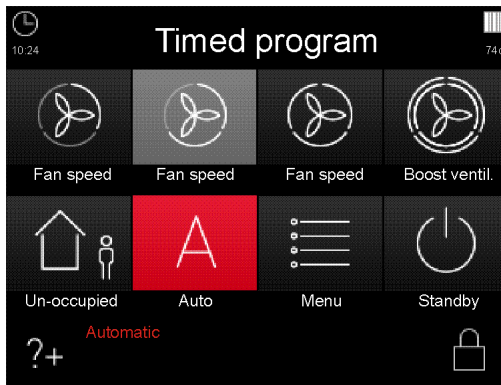

Fig. 8: Automatic mode automatic timer with active fan speed FS2

4.3.2.4.2 Automatic sensor

The operating mode **Automatic sensor** of the automatic mode requires the connection of an outdoor air quality / CO₂ or moisture sensor to the control of the ventilation unit. The analogue signal of the sensor is interpreted as a control signal for the rotational fan speed of the ventilation unit. When applying several sensors in a ventilation system, the output signal of a maximum value module will be used to control the ventilation unit.

First, the navigation buttons (red text background) and check marks are used to select whether the sensor is equipped with a power or voltage output (Electrical power: 4...20 mA, voltage: 0...10 V) and confirmed via Enter. Then the lowest point (characteristic curve start value p1) and the highest point (characteristic curve end value p2) of a characteristic curve assumed to be linear between these two points for the fan speed are parametrised between 17% and 100%. The nominal values (red text background) to be parametrised can be selected with the navigation buttons and the values adjusted with the +/- buttons.

Symbol	Description	Sensor output signal	
		0...10 V characteristic curve	4...20 mA characteristic curve
p1	Characteristic curve start value	U _{min} (V) \triangleq n _{min} (%)	I _{min} (mA) \triangleq n _{min} (%)
p2	Characteristic curve end value	U _{max} (V) \triangleq n _{max} (%)	I _{max} (mA) \triangleq n _{max} (%)

U-n characteristic curve diagram

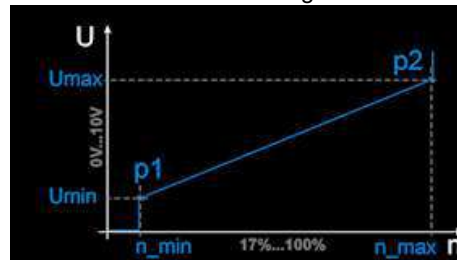

I-n characteristic curve diagram

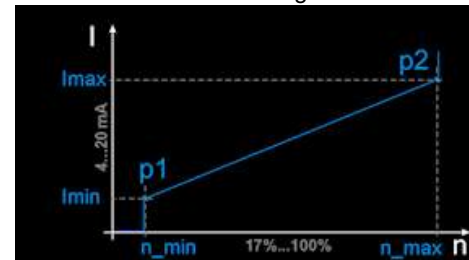

Table 11: Automatic sensor parametrisation

Plausibility check for sensors with power output:

- Concerns: Inputs A1 on the master controller (configured as 4...20 mA input)
- Error message if at the input a value of 0...3 mA is present for more than 1 s
- Reset of the error if I > 3.5 mA for at least 1 s

4.3.2.5 Sub-menu Date/time

In this menu the date and time are set. The nominal values (red text background) to be parametrised can be selected with the navigation buttons and the values adjusted with the +/- buttons.

4.3.2.6 Sub-menu Language selection

In this menu, the local language for the TFT control panel can be selected via the navigation buttons.

4.3.2.7 Sub-menu Screen dimming

In this menu, individual screen brightness and the duration until the dimming takes effect after non-operation can be adjusted using the navigation buttons.

- Duration until dimming in 1 min increments
- Dimming in 5% increments



Symbol	Description	Explanation/Actions
	Duration until dimming	Settings: 1 min...10 min until the dimming is activated after the TFT control panel was last used
	Degree of dimming	Settings: 5%...95% in relation to the basic brightness of the active screen
	Button Dimming test	With this button the set dimming can be tested. The screen is dimmed for 5 seconds according to the setting.

Table 12: Automatic sensor parametrisation

4.3.2.8 Sub-menu Key lock

The user interface of the TFT control panel can be deactivated by a password-protected key lock.



Symbol	Description	Explanation/Actions
	Password query	Enter the password <11111> and confirm with Enter. The current status "key lock" will be displayed on the touch pad.
	Button Deactivate key lock	After touching the button, the password is requested to deactivate the key lock. Enter the password <11111> and confirm with Enter.

Table 13: Activating /deactivating the key lock

4.3.2.9 Sub-menu Summer ventilation without bypass

The summer ventilation without bypass serves free cooling in ventilation systems without bypass shutter. When it is activated, the exhaust air fan is switched off and thus heat transfer from the extract air to the supply air prevented. To check the plausibility of the temperature conditions, the exhaust air fan is switched on additionally for 2 minute per hour to the currently active fan speed.

This menu indicates whether summer ventilation without bypass is possible. The operating mode summer ventilation without bypass can be released or not released. The summer ventilation function is released with the navigation buttons (red text background) and setting the check mark, then confirmed with Enter. In addition, the temperature limit for the summer ventilation function can be selected with the navigation buttons (red text background) and adjusted with the +/- buttons. If the boost ventilation mode is activated during the active phase, the summer ventilation is interrupted for the duration of the boost ventilation.

Abbreviation	Description	Explanation/Actions
t_som	Temperature limit summer ventilation	Temperature limit setting range: 20 °C...30 °C The summer ventilation is active when the extract air exceeds the set temperature limit and the outdoor air at the location of the unit is lower than the extract air at the location of the unit. In addition, the outdoor air at the location of the unit must be higher than the set limit for the outdoor air.

Table 14: Temperature limit summer ventilation without bypass parametrisation

 **To prevents draughts due to supply air temperature that is too cold, summer ventilation remains inactive below an outdoor air limit temperature. The limit value of the minimum outdoor air temperature can be adjusted in the main menu Setup between 12 °C ... 20 °C (factory setting: 13 °C).**

4.3.2.10 Sub-menu Supply heater

In this menu, a potentially existing supply heat module (electric heating register or hot water heating register) is displayed. The supply heater function can be activated or deactivated. The release of the supply heater function is selected with the navigation buttons (red text background) and setting a check mark and confirmed via Enter.

4.3.2.11 Sub-menu Ground heat exchanger shutter

In this menu, a potentially used GHE shutter (ground heat exchanger shutter) is shown. The GHE shutter function can be activated or deactivated. The release of the GHE shutter is selected with the navigation buttons (red text background) and setting a check mark and confirmed via Enter. In addition, the temperature limits for switching the GHE shutter can be selected with the navigation buttons (red text background) and adjusted with the +/- buttons.

Abbreviation	Description	Explanation/Actions
t_aut_max	Maximum external temperature	Adjustment range upper limit: 15 °C...30 °C If the external temperature is above the set limit value, the GHE shutter opens the outdoor air pipe to cool the outdoor air. → Cooling function
t_aut_min	Minimum external temperature	Adjustment range lower limit: -10 °C...14.5 °C If the external temperature is below the set limit value, the GHE shutter opens the outdoor air pipe to heat the outdoor air. → Frost protection function

Table 15: Temperature limit GHE shutter parametrisation

4.3.2.12 Sub-menu Brine defroster cooling



Only for unit version CLIMOS F 200 Basic without integrated defroster!

In this menu a potentially present Brine defroster is shown. The cooling function of the brine defroster can be activated and deactivated. The release of the brine defroster is selected with the navigation buttons (red text background) and setting a check mark and confirmed via Enter. In addition, the temperature limit for the cooling function can be selected with the navigation buttons (red background) and adjusted with the +/- buttons.

Abbreviation	Description	Explanation/Actions
t_sol	Cooling temperature	Adjustment range: 15 °C...30 °C If the outdoor air temperature is above the set limit value, the brine defroster is activated for cooling the outdoor air. → Cooling function

Table 16: Temperature limit brine defroster parametrisation

4.3.3 Boost ventilation mode with external boost ventilation actuator

Boost ventilation actuators, such as keys or limit switches (hygrostats) are usually installed in rooms from which air is extracted, such as bathrooms, toilets or kitchens. In this way, maximum ventilation can be activated locally within these rooms for a specific period to enable rapid extraction of high humidity and odours.

When this control module is activated, the functional features and displays described for the boost ventilation mode with LED control panel or TFT control panel apply. The boost ventilation mode is restarted each time it is activated and interrupts the current operating mode for the set duration. Afterwards, the unit reverts to the previously active operating mode. A manual change of the operating mode via connected control panels stops the boost ventilation function.

4.4 Maintenance by the user

For the user, maintenance of the ventilation unit and system is limited to replacing the filters periodically and cleaning the supply and extract air valves. The filters should be inspected every three months. Filter replacement should be carried out as necessary, but no later than once every six months.

As part of this process, please inspect the other filters in the ventilation system and replace them if necessary. The filter mats on the extract air valves (e.g. bathroom, kitchen, WC) should be replaced or cleaned every 2–3 months or when checking the degree of contamination at one's own discretion.



If the maintenance work is not carried out regularly, this will affect the functionality of the comfort ventilation system in the long run!

4.4.1 Replacing the unit filters



The system must not be operated without filters. During filter replacement and maintenance work, the ventilation unit must remain switched off!

Two high-quality original filters from the manufacturer are installed in the CLIMOS unit. The filters must be inspected following the respective message of the control panel or after display of a programmed digital output signal. In doing so, proceed as follows:

1. Set the unit to the standby mode or disconnect it from the mains.
2. If present, pull the red design filter cover **A** from the bracket of the casing lid.

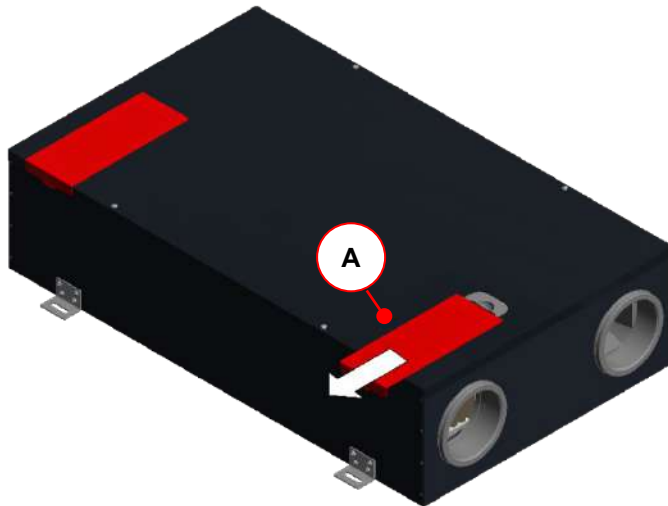

Fig. 9: Pulling out the design filter cover

3. Reach with your finger inside the recessed grip **B** of the filter compartment and pull the EPP filter cover out of the EPP housing.



The EPP filter cover may be very tightly lodged at the first filter replacement. You can lever the EPP filter cover out in the area of the recessed grip using a blunt object (e.g. the handle of a spoon).



Fig. 10: Filter compartment recessed grip

4. Remove the filter cover **C**.

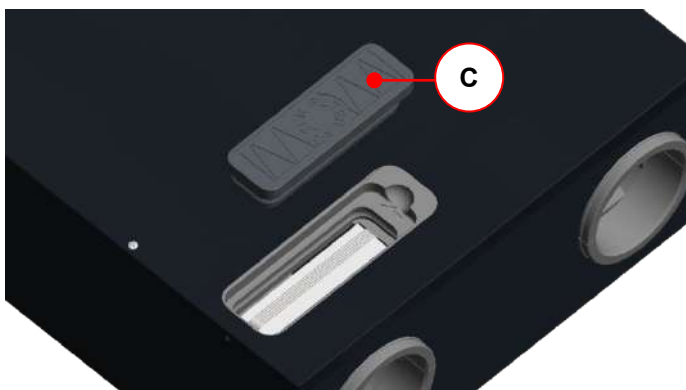

Fig. 11: Removing the EPP filter cover

5. Holding it by the strap, pull the filter **D** out of the filter compartment.

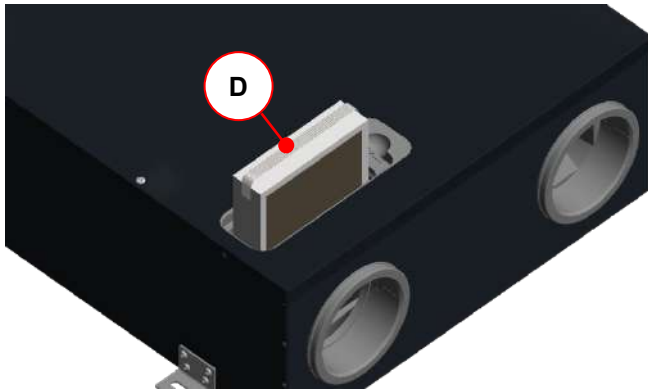

Fig. 12: Removing the filter

6. Insert the new filter.



The arrow E on the filter frame and the arrow F imprinted on the EPP filter compartment (next to the recessed grip) must point in the same direction!

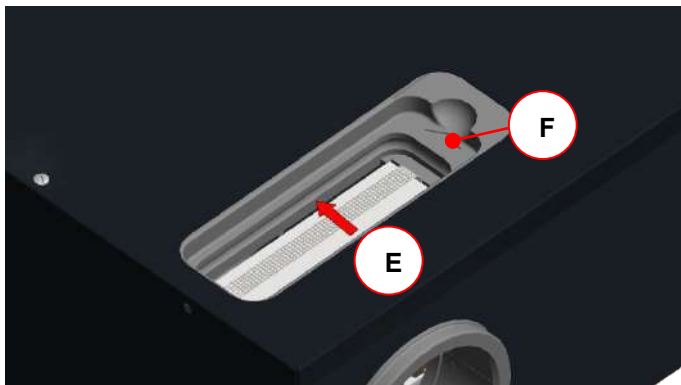

Fig. 13: Inserting the new filter



Depending on the unit type, filters with filter class ISO ePM1 must be inserted into the filter compartment of the outdoor air connector in accordance with the type label! The outdoor air connector is indicated by the symbol



7. Close all filter covers in reverse order.
8. Proceed in the same way for the other unit filter.
9. Reconnect the unit to the mains.

4.4.2 Resetting the filter running time

After completing the filter replacement, the counter for the filter running time must be reset. The filter running time can be reset with the respectively connected control panel or with a digital input signal (programmable with PC software as a special solution).

4.4.2.1 Reset filter running time with LED control panel

Symbol	Description	Explanation/Actions
	LED 10 Filter running time signal	If LED 10 lights up, then the filter running time has expired and a filter inspection must be carried out.
	Key Reset filter running time	To reset the filter running time, press and hold this key for > 3 s. LED 10 goes out. The counter starts the set filter running time.

Table 17: Reset filter running time with LED control panel

4.4.2.2 Reset filter running time with TFT control panel



Symbol	Description	Explanation/Actions
	Filter running time expired signal	If the symbol appears then the filter running time has expired and a filter inspection must be carried out.
	Button Menu mode	By touching the menu mode button, you access the main menu.
	Buttons Navigation	Touch the navigation buttons to select the main menu Settings and confirm with the Enter button.
	Buttons Navigation	Touch the navigation buttons to select the sub-menu Filter and confirm with the Enter button.
	Button Check mark	By touching the check mark button, the filter running time reset is selected
	Button Enter	Confirm by touching the Enter button
	Button Cancel/return	Exit the menu levels by touching the cancel/return button until the start menu appears.

Table 18: Sequence of steps to reset filter running time with TFT control panel

 Use check list A to document the maintenance work completed.

4.4.3 What should I do in case of a fault?

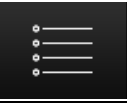
Contact the installation technician in case of a fault. Note the error display or malfunction code of the used control panel. Also note the type of your CLIMOS unit, see the type label on the side of the unit.

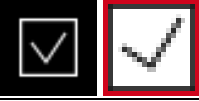
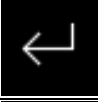
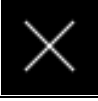
The mains connection must always be present, unless the CLIMOS unit has to be shut down due to a serious fault, for maintenance work or for some other urgent reason.

 **As soon as the unit is disconnected from the mains, the apartment will no longer be mechanically ventilated. This may result in moisture and mould problems in the apartment. Therefore, you should avoid switching off the CLIMOS unit for long periods!**

4.5 Disposal

The unit must be disposed of in an environmentally-friendly manner. Do not dispose the unit with your domestic waste.

 **Packaging materials, consumables and waste equipment must be disposed of at the end of their useful life in accordance with the applicable regulations in your country.**

5.2.2 Checking the scope of delivery

If the delivered product is found to be damaged or incomplete, please contact the supplier immediately. Included in the scope of delivery are:

- Ventilation unit CLIMOS, check the type label if it is the correct unit version (Basic / Comfort) and type R (right-type A) or L (left - type B)
- 230 V mains cable with non-heating device plug connection, 2 m long
- CAT5 network cable, 1.5 m long
- Adapter board
- Adapter board housing made of transparent plastic
- Control panel(s), type and number depending on the order
- 4 mounting brackets, including 16 crosshead screws
- Instruction manual
- Product labels showing energy efficiency
- Design filter cover (as standard for Comfort, optional for Basic)

5.3 Mounting

For the CLIMOS unit, the distances from adjacent surfaces shown in Fig. 15 must be observed. Please note that these clearances are not shown to scale. The surfaces are allowed to be made from flammable materials:

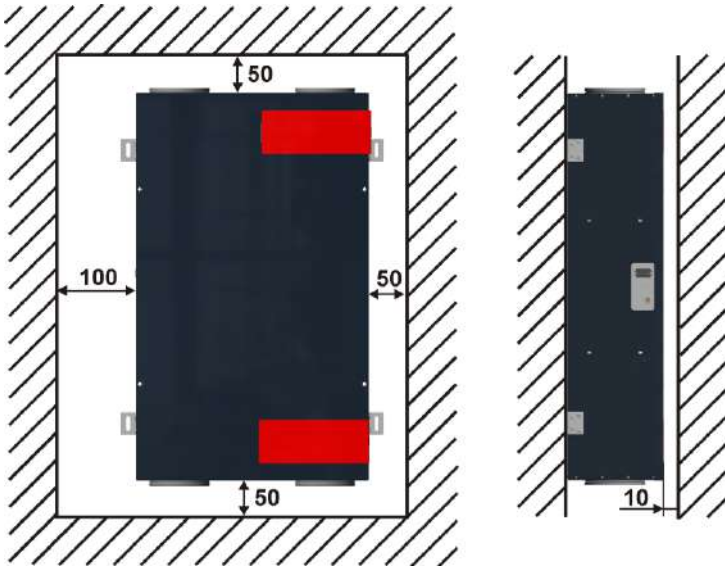

Fig. 15: Distances from adjacent surfaces in mm

The following fitting positions are available for the CLIMOS unit:

- Suspended from the ceiling or reclined (horizontal)
- Mounted on the wall (horizontal or vertical)
- Mounted sloped on the wall (horizontal or vertical)



The exhaust air connection



must always be on the top!

5.3.1 Installation preparations

First attach 2 of the included mounting brackets using 4 crosshead screws each to the longitudinal sides of the CLIMOS unit.

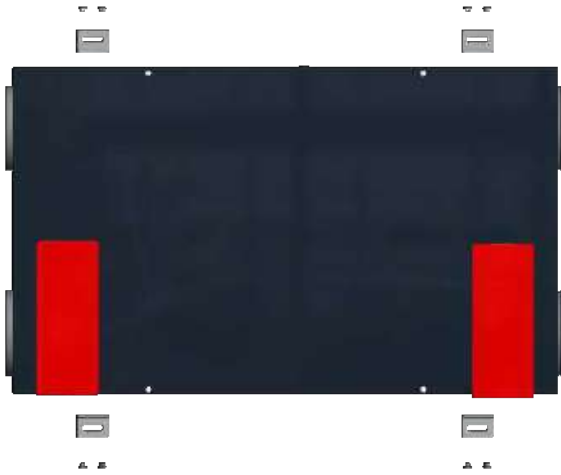

Fig. 16: Attaching the mounting brackets

Check in advance the required carrying capacity of the respective mounting surface (dead weight of the CLIMOS approx. is 30 kg) and the secure mounting option using the mounting brackets. If the unit is attached to a wooden or light construction element we recommend the insertion of a vibration-reducing spacer ring for each mounting bracket.

5.3.2 Installation position: suspended from the ceiling

In the installation position suspended from the ceiling, the unit is mounted horizontally to the ceiling in the slotted holes (38x10 mm) of the 4 mounting brackets using suitable fixing elements depending on the ceiling structure. If you want to mount the CLIMOS unit on a suspended ceiling, we recommend the installation of the product-related dry wall inspection flap in the suspended ceiling. The distance between the bottom edge of the structural slab to the bottom edge of the dry wall inspection flap is at least 270 mm. In this case, the ventilation unit is attached to the structural slab at the centre of the opening area of this maintenance hatch.



Fig. 17: Installation position suspended from the ceiling

5.3.3 Installation position: reclined

In the installation position reclined, the unit is mounted horizontally to the floor in the slotted holes (38x10 mm) of the 4 mounting brackets using suitable fixing elements depending on the floor structure.

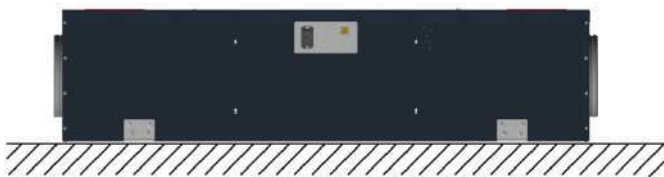

Fig. 18: Installation position inclined

5.3.4 Installation position: mounted horizontally on the wall

In the installation position mounted horizontally on the wall, the unit is mounted horizontally to the wall in the slotted holes (38x10 mm) of the 4 mounting brackets using suitable fixing elements depending on the wall structure.



The exhaust air connection for the structures type A or type B must always be on the top!

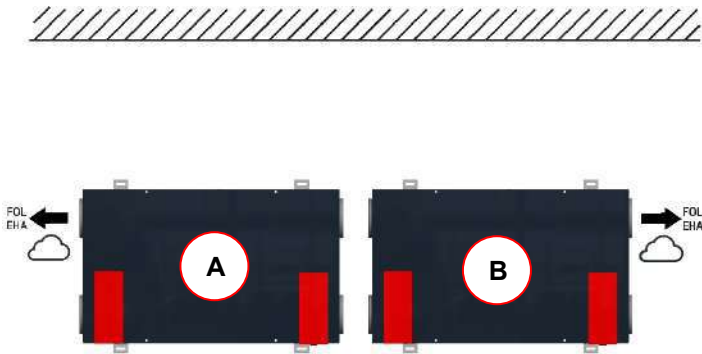

Fig. 19: Installation position mounted horizontally on the wall

5.3.5 Installation position: mounted vertically on the wall

In the installation position mounted vertically on the wall, the unit is mounted vertically on the wall in the slotted holes (38x10 mm) of the 4 mounting brackets using suitable fixing elements depending on the wall structure.



The exhaust air connection for the structures type A or type B must always be on the top!

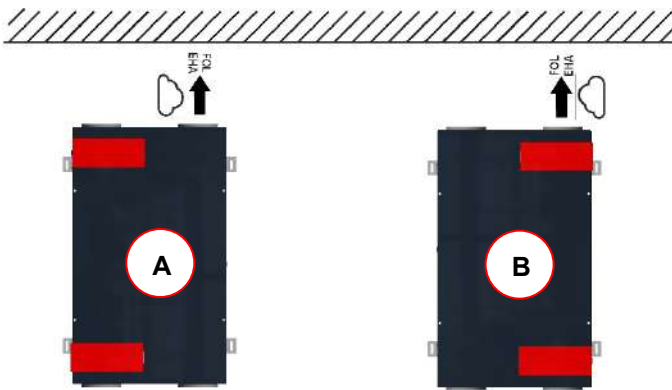

Fig. 20: Installation position mounted vertically on the wall

5.3.6 Installation position: mounted horizontally on the wall slope

In the installation position mounted horizontally on the wall slope, the unit is mounted horizontally on the wall slope in the slotted holes (38x10 mm) of the 4 mounting brackets using suitable fixing elements depending on the wall structure.



The exhaust air connection for the structures type A or type B must always be on the top!

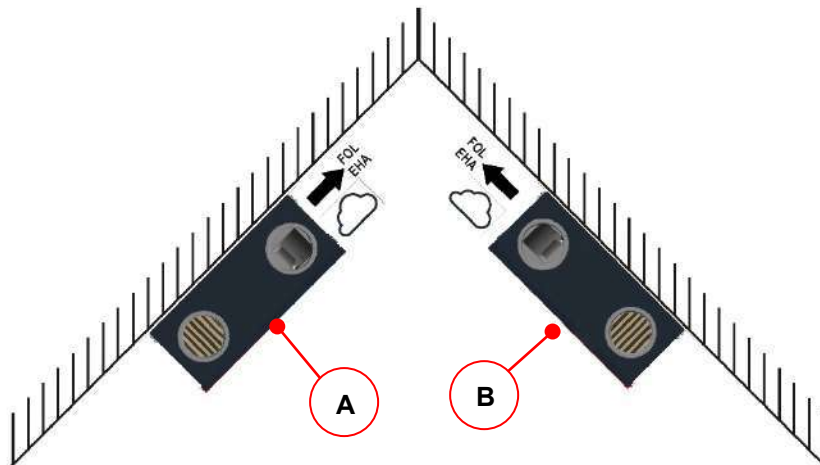

Fig. 21: Installation position mounted horizontally on the wall slope

5.3.7 Installation position: mounted vertically on the wall slope

In the installation position mounted vertically on the wall slope, the unit is mounted vertically on the wall slope in the slotted holes (38x10 mm) of the 4 mounting brackets using suitable fixing elements depending on the wall structure.



The exhaust air connection for the structures type A or type B must always be on the top!

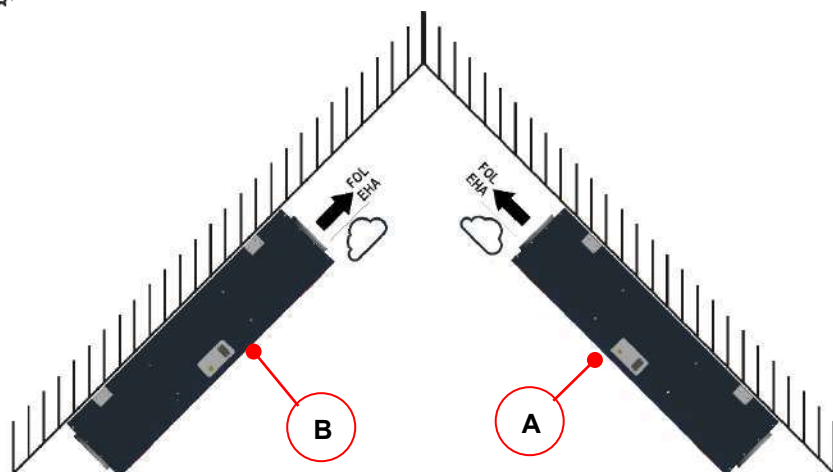

Fig. 22: Installation position mounted vertically on the wall slope

5.3.8 Connecting the ventilation tubes

The following points must be observed when installing the ventilation tubes:

- Attach the different types of ventilation tube provided with the ventilation system to the relevant connectors according to the unit's type **R (right – type A) / L (left –type B)** (see air connections sticker next to the type label).

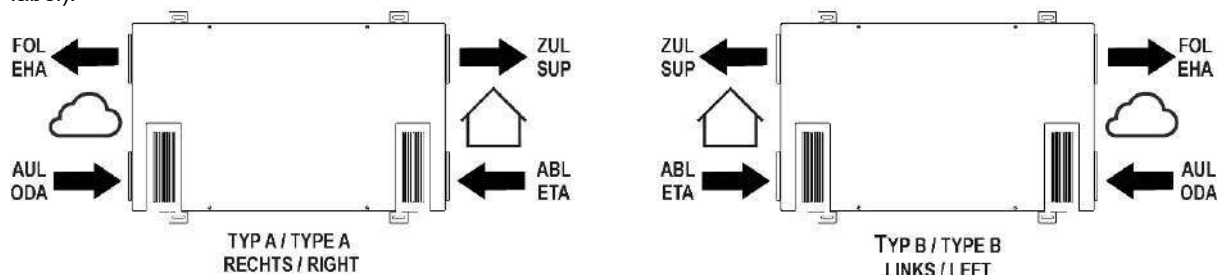

Fig. 23: Arrangement of air connections according to type R (right - type A) / L (left - type B)

- Remove the sealing caps from the air connectors.
- Using ventilation tube materials with the lowest possible air resistance, connect the ventilation technology components to one another so that they are air-tight.
- The unit connectors are made from EPP and have a sleeve size of DN125.
- The outdoor air and exhaust air tubes must be insulated in such a way that they are sealed against vapour diffusion. This prevents condensate from forming on the outside of the ventilation tubes.
- If – when installing the exhaust air tube – it is not possible to avoid a low point between the exhaust air connector on the unit and the exhaust air outlet, a connection to the condensate drain must be provided at this point. This is because the exhaust air is saturated with steam at cold outdoor temperatures and droplets may be deposited on the inner wall of the tube.
- The exhaust air pipework that runs from the unit connector to the roof terminal must not be straight. Otherwise, any ice that forms could drop onto the blades of the exhaust air fan when it thaws, causing damage to the blades.

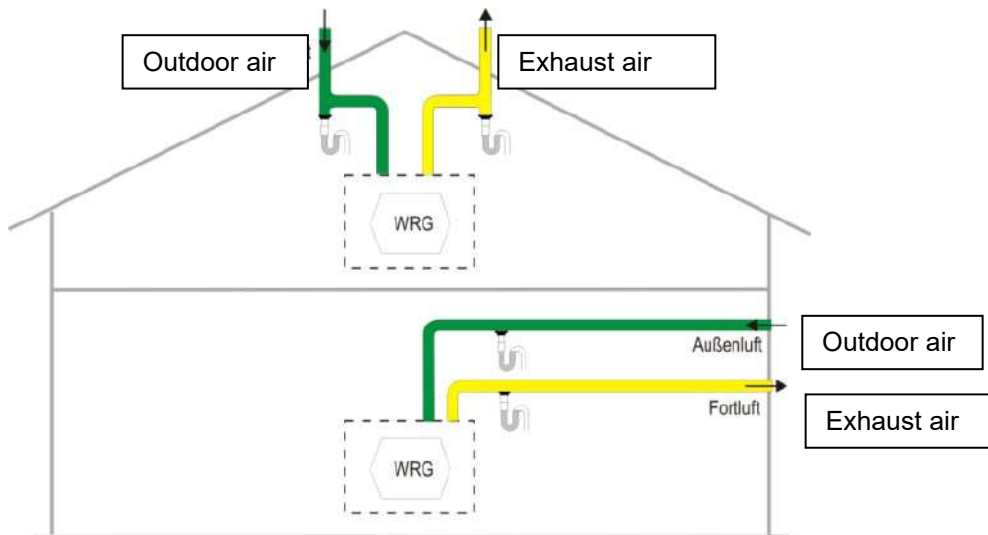

Fig. 24: Drainage arrangement for outdoor and exhaust air tubes

- If an attenuator is fitted at the exhaust air connector, it must be routed upwards with a bend to prevent it being drenched by condensate running back from the exhaust air tube.
- If the exhaust air is routed above the roof, a double-walled or insulated roof passage must be installed. This prevents condensate from forming between the roof boards.
- For the supply and extract air ducts, we recommend using thermal and vapour-tight insulation to prevent unnecessary temperature losses in both the summer and winter.

5.4 Electrical connections



Electrical connections are to be implemented in accordance with the standards specific to the relevant country and by qualified personnel only!

The electrical mains power supply of the CLIMOS is via the 3-core non-heating device plug connection **A** with the mains cable. The CAT5 network cable is connected to the RJ45 socket **B**. Both plug connections are found on the interface sheet D on the casing side of the air connections. Analogue and digital input/output signals from sensors (e.g. room air quality sensors) or actuators (e.g. boost ventilation sensors) are connected to the corresponding clamping points of the Master/controller inside the control casing. As needed, the cable guides that are pre-punched in the casing sheet **C** must be broken out and the cables of the sensors/actuators guided through the cable glands M16.

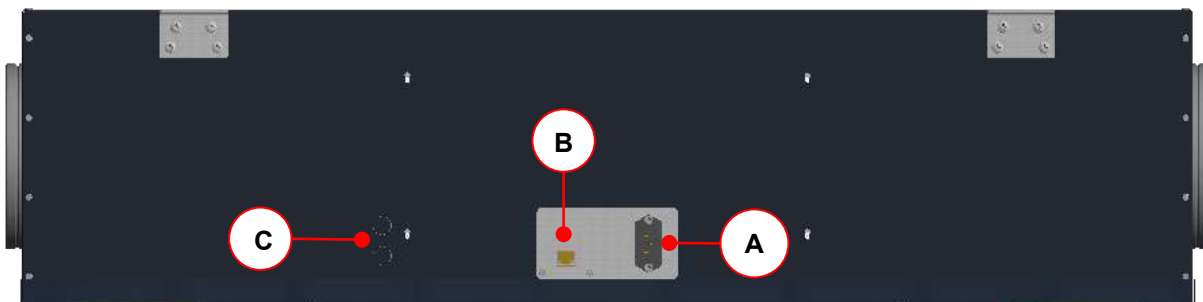

Fig. 25: Side of the casing with electrical connections

Item	Description
A	3-- pole rubber connector
B	RJ45 socket
C	Pre-punched cable guide (2x) for M16 cable gland
5.9.5	Circuit diagram CLIMOS Basic series
5.9.6	Circuit diagram CLIMOS Comfort series
5.9.7	Master Controller terminal assignment

Table 19: Overview of the electrical connections



The RJ45 plug connection only serve the internal system RS485-BUS! Any other use results in damage to the control and operating modules!

5.4.1 Adapter board connection

The adapter board with the double RJ45 plug connection and the 5-core screw terminal X1 serve the communication of the modules via the internal RS485-BUS. The CAT5 network cable creates the internal connection between the RJ45 socket of the NOVUS and one of the two RJ45 sockets of the adapter board.

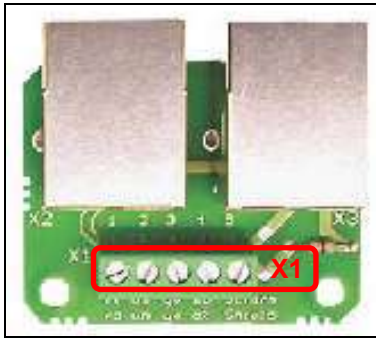

Fig. 26: Adapter circuit board

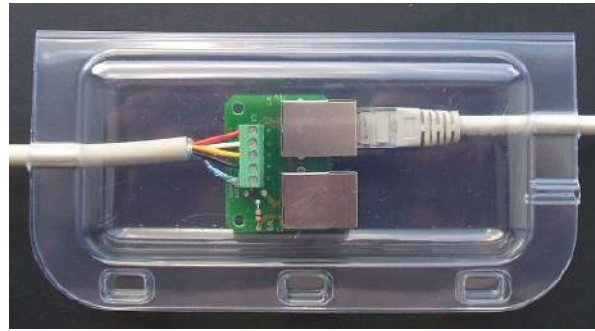

Fig. 27: Housing for adapter board

A shielded 4-core cable is connected to the 5-pin screw terminal of the adapter board, which connects the adapter board with the 5-pin screw terminal of the connection board of the control panel. To protect it from faulty voltage, short circuits and dust, the adapter board must be mounted in the clear plastic housing. The cables connected to the adapter board must be placed in the cable ducts of the housing and fixed via the triple clip fasteners of the hinged lid. We recommend the use of a cable type J-Y(ST)Y 2x2x0.6 LG interior cable with colour coding according to VDE0815.

Terminal X1 (Adapter board / control panel)	Wire	Signal
X1.1	red	24P
X1.2	white	RX
X1.3	yellow	TX
X1.4	black	GND
X1.5	Aluminium coloured	Shield

Table 20: Terminal assignment for terminal X1 adapter board and terminal X1 control panel

5.4.2 Connecting TFT control panel

The cable type J-Y(ST)Y 2x2x0.6 must be connected to terminal X1 of the connecting board according to Table 20. The ribbon cable connects the connecting board with the board of the TFT control membrane.

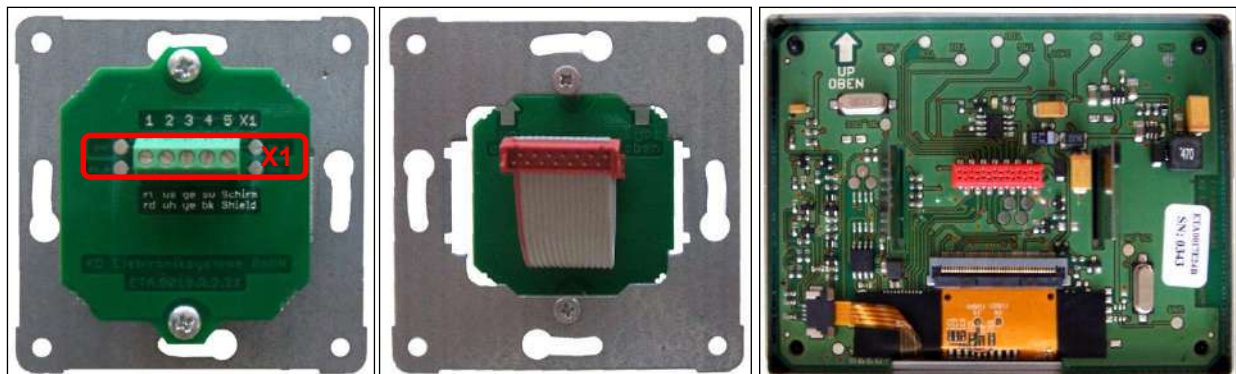

Fig. 28: Connecting board with terminal X1 on a concealed base plate; ribbon cable to the connecting board; TFT control panel board (from left to right)



The reverse current protected plugs of the ribbon cable must be carefully inserted into the sockets of the respective boards!

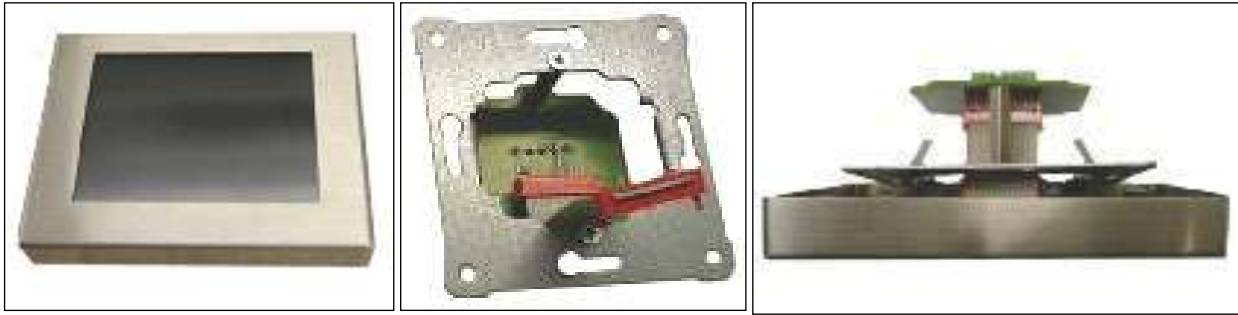

Fig. 29: Touch pad with stainless steel frame; Ribbon cable of the connecting board; touch pad with stainless steel frame latched into the concealed base plate (from left to right)

When the control panel is ready for use, the slimmer side of the stainless-steel frame must point upwards. The concealed base plate must be positioned in such a way that the ribbon cable of the connecting board is attached curved downwards to the TFT control panel. The spring steel clamps mounted to the back of the touch pad clasp into the concealed base plate and pull the stainless-steel frame securely to the wall.

5.4.3 Connecting several TFT control panels

Up to three TFT control panels can be connected as control panels for the ventilation unit. In terms of hardware, the TFT control panels must be connected in parallel to the X1 terminal of the adapter board according to the wire configuration Table 20. The TFT control panels must be commissioned in sequence and newly addressed (factory setting standard address = 1). Addressing of the TFT control panels takes place on the software level in the Setup/sub-menu More than one control panel.

Symbol	Description	Explanation/Actions
	Addressing two TFT control panels	Connect the first TFT control panel
	Button Menu mode	By touching the menu mode button, you access the main menu.
	Buttons Navigation	Touch the navigation buttons to select the main menu Setup and confirm with the Enter button.
	Button Password	Password query Enter the password _ _ _ _ and confirm with the Enter button.
	Buttons Navigation	Touch the navigation buttons to select the sub-menu Several control panels and confirm with the Enter button.
	Buttons Navigation	Touch the navigation buttons to select the address number 2 and confirm with the Enter button.
	Addressing two TFT control panels	Connect the second TFT control panel The sequence of steps for software addressing is not needed as the address number = 1 (factory setting)
	Addressing three TFT control panels	Connect the second TFT control panel Perform the sequence of steps for software addressing as before, allocate address number 3.
	Addressing three TFT control panels	Connect the third TFT control panel The sequence of steps for software addressing is not needed as the address number = 1 (factory setting)

Table 21: Sequence of steps connecting / addressing several TFT control panels



Connecting several control panels with the same address number results in a communications error!

The operating mode of the ventilation unit is based on the latest control command on one of the connected TFT control panels.

5.4.4 Connecting the LED control panel

Operating the ventilation unit is only possible with a control panel type LED control panel. The cable type J-Y(ST)Y 2x2x0.6 must be connected to terminal X1 of the connecting board according to Table 20. The ribbon cable connects the connecting board with the board of the LED control membrane.

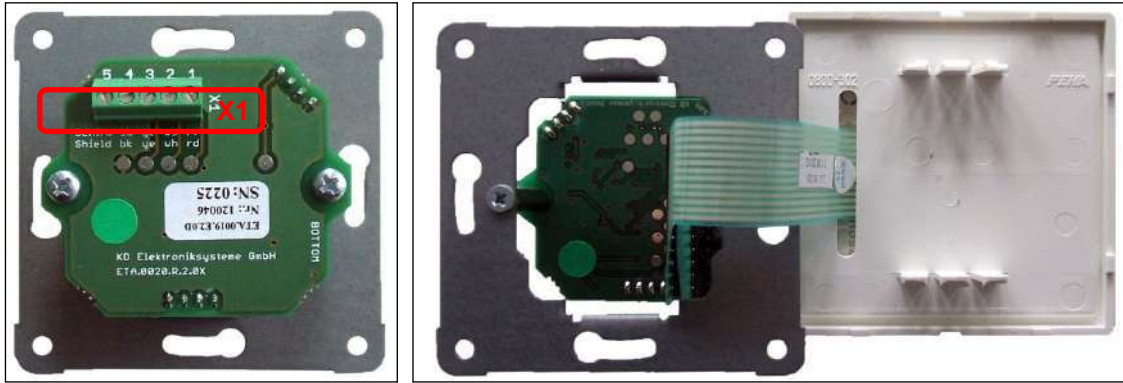

Fig. 30: Connecting board with terminal X1 on a concealed base plate; ribbon cable of the connecting board; rear side of LED control membrane (from left to right)



During installation do not remove the ribbon cable from the connecting board, instead guide the LED control membrane diagonally through the PEHA cover frame!

5.4.5 Connecting external actuators/sensors to the Master Controller

To connect the cables of actuators/sensors to the Master Controller proceed as follows:

1. Disconnect the CLIMOS unit from the mains power supply.
2. If present, pull the red design filter cover **A** from the bracket of the casing lid.

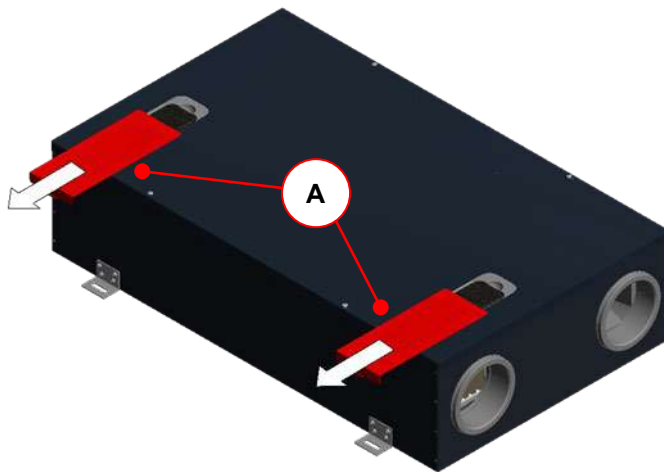

Fig. 31: Pulling out 2 design filter covers **A**

3. Open the quarter turn locks **B** by a 90° turn of the captive screw.

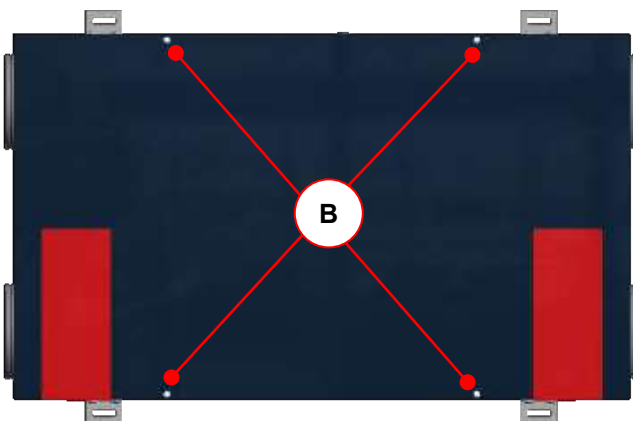

Fig. 32: Casing lid with 4 quarter turn locks **B**

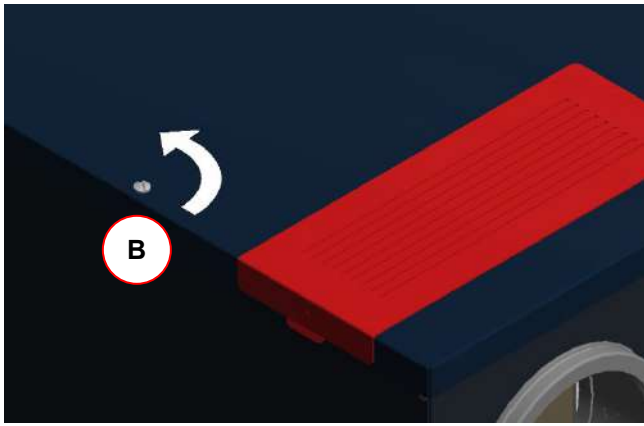

Fig. 33: Quarter turn lock with captive screw

4. Remove the casing lid **C** and pull the cable for the potential equalisation off the contact pin of the casing lid.

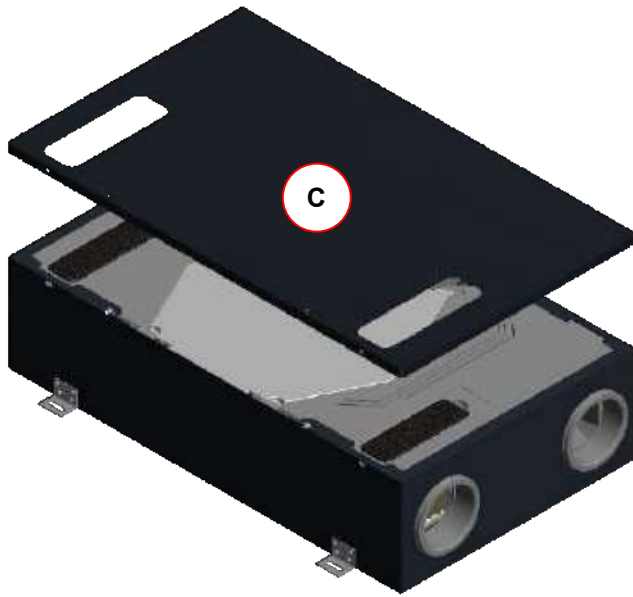

Fig. 34: Removing the casing lid **C** from the unit

5. Loosen the 2 fixing screws **D** of the control casing by approx. 4-6 mm and pull the cable for the potential equalisation off the contact pin of the control casing.

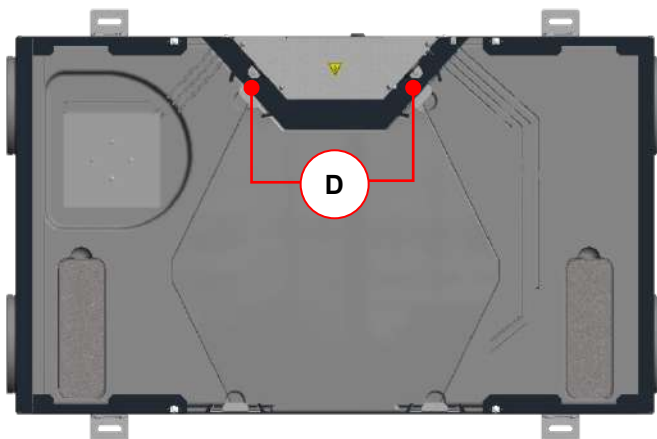

Fig. 35: Screws **D** for fixing the control casing

6. Push the control casing approx. 3-5 mm in the direction of the arrow in order for the press-in keyhole fasteners of the 4 keyholes **E** of the casing wall unlock.

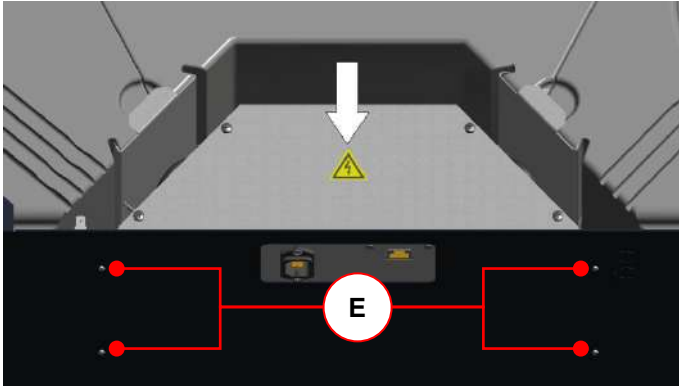

Fig. 36: Unlocking the keyhole connection

7. Remove the control casing step by step according to the directions of the arrows.

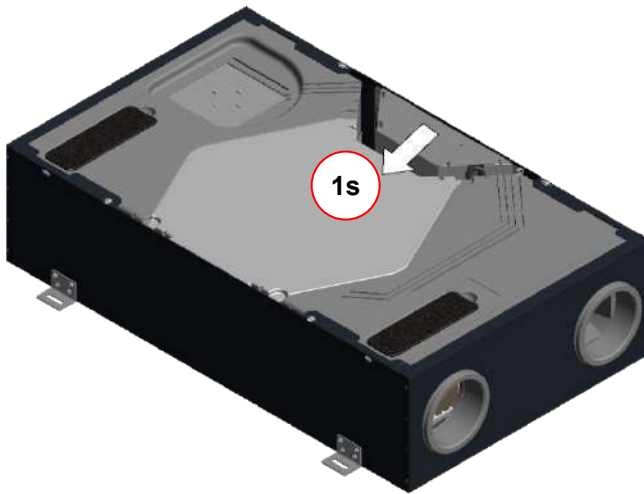

Fig. 37: Pushing the control casing in the direction of the heat exchanger

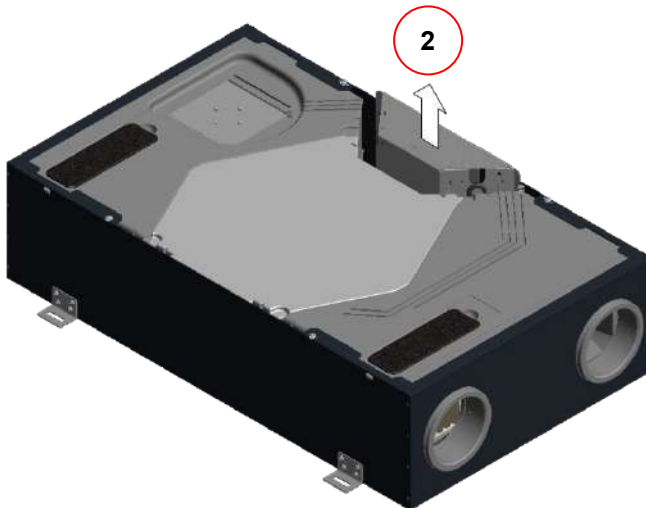

Fig. 38: Removing the control casing towards the top

8. Guide the cable through one of the two rubberised grommets **F** of the control casing.

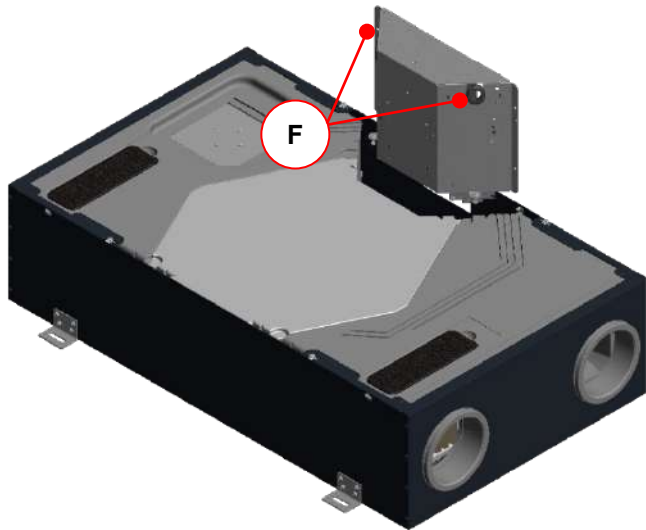

Fig. 39: 2 cable grommets **F** on the control casing

9. Clamp the cable of the actuator/sensor to the allocated clamping points according to Annex 3 Master Controller terminal assignment.

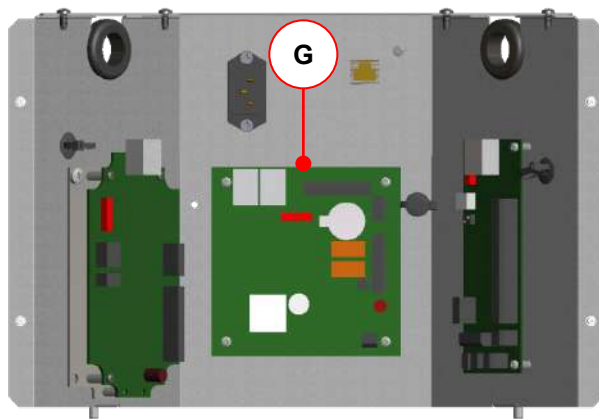

Fig. 40: Control casing with Master Controller **G**

10. Reassemble the control casing in reverse order. Insert the press-in keyhole fasteners of the control casing into the keyholes **E**.

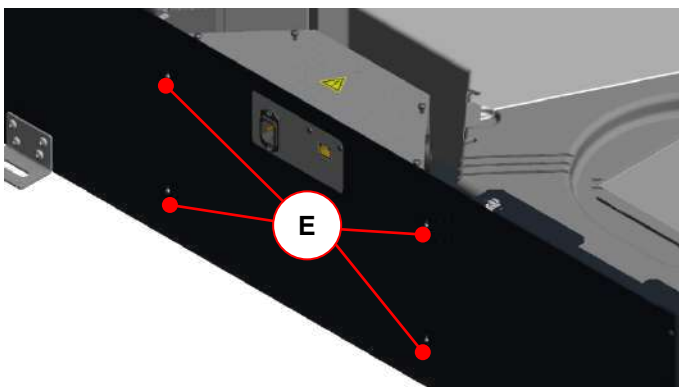

Fig. 41: Establishing the keyhole connection

11. Place the cable in the free space between the control casing and EPP modules.



Make sure that no cables are pinched underneath the control casing!

12. Turning the fixing screws **D** to the right into the press nuts fixates the control casing by latching the press-in keyhole fasteners into the neck of the keyholes. During this, the press-in keyhole fasteners and thus the control casing are moved around 3-5 mm in the direction of the arrow.

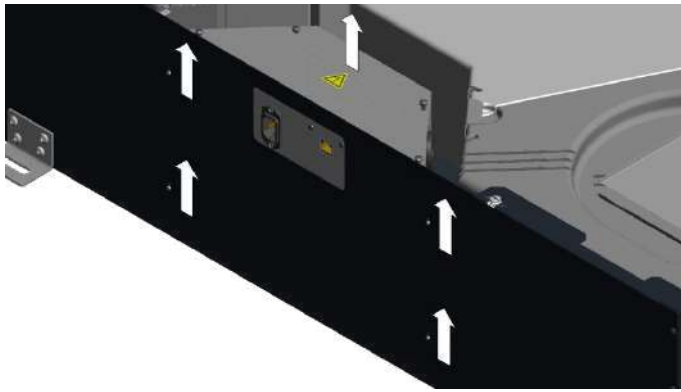

Fig. 42: Latching the control casing

13. Connect the cables for the potential equalisation to the corresponding contact pins of the casing parts.
14. Close the casing lid by turning the 4 captive screws of the quarter turn locks **B** by 90°.
15. Reconnect the unit to the mains.

5.4.5.1 Connecting external boost ventilation keys

Boost ventilation mode can be activated by operating one or more boost ventilation keys (connected in parallel). The keys that are usually installed as part of the switch range design are triggered when the boost ventilation mode is selected. To establish the potential-free connection between the button and the circuit terminal X1, use a 2-core cable as a minimum (recommended cable type: J-Y(ST)Y 2x2x0.6). The cable is inserted into the CLIMOS through one of the pre-cut cable guides.

Master Controller X1 terminal	Wire of boost ventilation key cable
X1.12	Wire 1
X1.13	Wire 2 (GND)

Table 22: Terminal assignment of boost ventilation key connection

5.4.5.2 Connecting external sensors

The operating mode **Automatic sensor** of the automatic mode is controlled by an analogue sensor signal that is generated by one or several sensors. To establish the connection between the sensor module and Master Controller terminal X2, use the type of cable stipulated for transmitting the sensor signal. The cable is inserted into the CLIMOS through one of the pre-cut cable guides.

Master Controller X2 terminal	Sensor module cable wire
X2.7 (analogue input1)	Wire 1(sensor signal 0–10 V or 4–20 mA)
X2.8 (GND)	Wire 2 (GND)

Table 23: Terminal assignment of analogue sensor signal connection

5.4.5.3 Connecting the status relay

A status relay on the Master Controller signals the operating status of the fans (factory setting).

Fan off: contacts open

Fan on: contacts closed

Master Controller X1 terminal	Contact designation
X1.9	Status relay make contact (max. 24 V switching voltage)
X1.10	Status relay two-way contact (max. 24 V switching voltage)

Table 24: Terminal assignment of status relay connection

5.4.5.4 Connecting external release

The operation of the system can be activated or deactivated by an external release signal. The potential-free release contacts are located next to the terminal X1 and are bridged ex-factory.



We recommend the use of a hygrostat in the extract air with switching function NC as an external release! The nominal value of the hygrostat should be set to 80% RH.

Master Controller X1 terminal	Contact designation
X1.14	External release
X1.15	External release (GND)

Table 25: Terminal assignment of external release connection

When the bridge is removed and there is no external release, the following displays are generated:

TFT control panel	LED control panel
	L1 and L7 light up

Table 26. Display of no external release

5.4.5.5 Connecting digital inputs and outputs

The digital inputs and outputs DIO1 and DIO2 can only be programmed with the configuration software. At the factory, the following parameters are specified:

DIO1: Activate automatic (as a digital input signal)

DIO2: General message (as a digital output signal)

Master Controller X2 terminal	Contact designation
X2.1	Digital input or output 1 (can be parametrised)
X2.2	Digital input or output 1 (GND)
X2.3	Digital input or output 2 (can be parametrised)
X2.4	Digital input or output 2 (GND)

Table 27: Terminal assignment connection DIO1 and DIO2

5.4.6 Operation without connected control panel

To operate the ventilation unit without control unit, the control runs according to the last set operating mode.



The control unit may only be disconnected from the BUS when it has zero potential. Disconnecting during operation results in a communication error!

5.5 Commissioning

5.5.1 Readiness for operation



The unit is ready for operation once all the requirements of the safety regulations and installation conditions have been met. In particular, this means ensuring that the ventilation tube material is clean and that all the ventilation technology components required to operate the system are present, properly installed and ready for operation.





Check all the safety-related components and carry out a function test.

5.5.2 Adjusting the air volume flow

Once you have checked that the CLIMOS unit is ready for operation, you can commission it as described below. The ventilation unit is set to nominal ventilation according to the system design for the entire outdoor air volume flow. This nominal air volume flow is parametrised according to the characteristic curve diagram 1 Fig. 43 (with control unit TFT control panel) under Setup / sub-menu fan speeds or according to Table 29 (with control unit LED control panel).

5.5.2.1 Adjusting the nominal air volume flow with TFT control panel

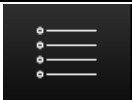
To adjust the ventilation system, fan speed 2 (FS2) is parametrised for the nominal air volume flow. The following settings must be made with the TFT control panel:

Symbol	Description	Explanation/Actions
	Button Menu mode	By touching the menu mode button, you access the main menu.
	Buttons Navigation	Touch the navigation buttons to select the main menu Setup and confirm with the Enter button.







	Button Password	Password query Enter the password _ _ _ _ _ and confirm with the Enter button.
	Buttons Navigation	Touch the navigation buttons to select the sub-menu Fan speeds and confirm with the Enter button.
	Button Fan speed 2 (FS2)	Touch the fan speed 2 button (FS2) to activate this fan speed
	Buttons Navigation	Parametrise fan speed 2 (FS2) according to the characteristic curve 1 for the nominal air volume flow
	Button Enter	Confirm by touching the Enter button
	Button Cancel/return	Exit the menu levels by touching the cancel/return button until the start menu appears.

Table 28: Sequence of steps for adjusting the nominal air volume with a TFT control panel



The values for the balance compensation are pre-set at the factory and should only be changed if required.

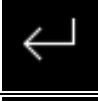
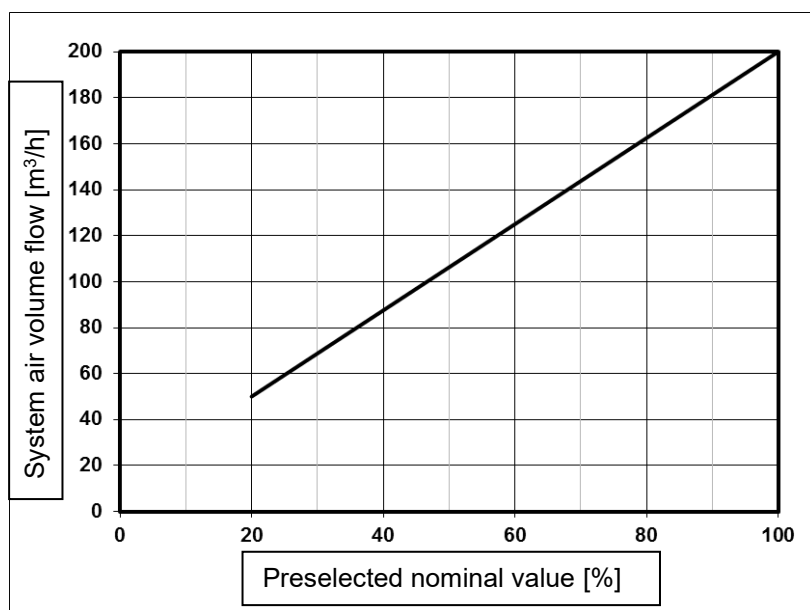

Fig. 43: Diagram 1, values to be set for the nominal air volume flow CLIMOS unit with fan speed 2 (FS2)

5.5.2.2 Adjusting the nominal air volume flow with LED control panel

To adjust the ventilation system, the speed corresponding to the nominal air volume flow is set on the LED control panel. The 7 speeds of the LED control panel are allocated nominal values for the fans at the factory according to Table 29. The speed to be set for the nominal air volume flow must correspond to the nearest nominal value from diagram 1 Fig. 43.

LED control panel speed	Preselected nominal value [%]
1	20
2	33
3	46
4	60
5	73
6	81
7	100

5.5.3 Adjusting the valves



At the start of volume flow measurement, make sure that the supply air and extract air valves are open as wide as possible.

- Set the fans to the nominal air volume flow
- The valves are adjusted while this fan speed is kept
- Adjust the valve orifices, throttle valves or throttle foam inserts
- Measure the volume flows at the outlets using a volume flow hood and flow meter (see air volume protocol)
- Readjust the valves
- Lock the valves, shutters and throttles in their adjusted positions
- Record the set air volumes and all other settings in the documentation intended for this purpose

5.6 Menu settings by qualified persons/service staff



Changes to the password-protected parameters may only be carried out by qualified persons or service staff!

5.6.1 Main menu Setup

The main menu **Setup** is divided into eight sub-menus, access to which is password protected.

Symbol	Description	Explanation/Actions
	Button Menu mode	By touching the menu mode button, you access the main menu.
	Buttons Navigation	Touch the navigation buttons to select the main menu Setup and confirm with the Enter button.
	Button Password	Password query Enter the password _ _ _ _ _ and confirm with the Enter button.
	Buttons Navigation	Touch the navigation buttons to select the respective sub-menu and confirm with the Enter button.

Table 30: Sequence of steps access to the main menu Setup



The settings in the sub-menus are only saved when the enter button is touched!

5.6.1.1 Sub-menu Frost protection

In the sub-menu frost protection, the following settings are carried out:

- Parametrisation of the temperatures, () values factory setting:
 - Frost protection limit outdoor air Eco (-3.0 °C)
 - Frost protection limit outdoor air Safe (-2.0 °C)
 - Frost protection limit outdoor air moisture heat exchanger (-3.0 °C)
 - Frost protection limit minimum supply air temperature (5.0 °C)
- Selection of defroster heater type, only for CLIMOS F 200 Basic unit version:
 - Electric defroster
 - PTC defroster
 - Brine defroster

Symbol	Description	Explanation/Actions
	Buttons Navigation	Temperatures Touch the navigation buttons to select (red text background) and confirm with the Enter button.
	Buttons Navigation	Frost protection limits The nominal values (red text background) to be parametrised can be selected with the navigation buttons and the values adjusted with the +/- buttons.
	Buttons Enter Cancel/return	Confirm by touching the Enter button and exit the menu level via the Cancel/return button.



	Buttons Navigation	Selecting the defroster heating type Select the respective type by touching the navigation buttons (red text background).
	Button Check mark	By touching the check mark button, the type of defroster heating is specified.
	Button Cancel/return	Exit the menu levels by touching the cancel/return button until the start menu appears.

Table 31: Parametrisation sub-menu Frost Protection

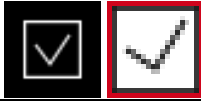

When temperature drops below a frost protection limit, a potentially present frost protection component is activated. If the temperature remains beneath the frost protection limit, it results in shutting off the fans and an error message.

5.6.1.2 Sub-menu Fan speeds

In the sub-menu Fan speeds, settings can be made for the fan performance and balance compensation for all three fan speeds. The supply air fans are parametrised separately in 1% increments between 20% and 100% per fan speed. If required, balance compensation for each fan speed is implemented by adjusting the extract air fan in the range of -50% ... +50%. Varying fan performance (imbalance) is calibrated by the service technician, depending on the system configuration, and fixed by the balance controller.



A change of the fan performance in the main menu Settings/Fan speed can result in a change of the balance behaviour, especially in the upper and lower limits of the fan characteristic curve.







Symbol	Description	Explanation/Actions
	Button Fan speed 1 (FS1)	Activate FS1 with the button fan speed 1 and parametrise it with the navigation buttons. Setting range: 20% < FS1 < FS2 An imbalance can be set with the +/- buttons.
	Button Fan speed 2 (FS2)	Activate FS2 with the navigation button fan speed 2 and parametrise it with the navigation buttons. Setting: FS2 = nominal air volume flow An imbalance can be set with the +/- buttons.
	Button Fan speed 3 (FS3)	Activate FS3 with the navigation button fan speed 3 and parametrise it with the navigation buttons. Setting range: FS2 < FS3 < 100% An imbalance can be set with the +/- buttons.
	Buttons Enter Cancel/return	Confirm by touching the Enter button and exit the menu level via the Cancel/return button.

Table 32: Parametrisation sub-menu fan speeds

5.6.1.3 Sub-menu Supply heater

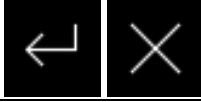
In the sub-menu Supply heater, the following settings are carried out:

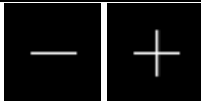
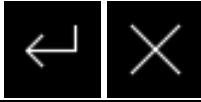
- Parametrisation of the channel temperature (50 °C factory setting)
- Selecting the supply heater register type:
 - Electric heating register
 - Hot water heating register

Symbol	Description	Explanation/Actions
	Buttons Navigation	Channel temperature Touch the navigation buttons to select (red text background) and confirm with the Enter button.
	Buttons + / -	Set the channel temperature with the +/- buttons.
	Buttons Enter Cancel/return	Confirm by touching the Enter button and exit the menu level via the Cancel/return button.
	Buttons Navigation	Selecting the supply heater register type Select the respective type by touching the navigation buttons (red text background).



		Button Check mark	By touching the check mark button, the type of Supply heater register is specified.
		Button Cancel/return	Exit the menu levels by touching the cancel/return button until the start menu appears.

Table 33: Parametrisation sub-menu Supply heater

5.6.1.4 Sub-menu Summer ventilation without bypass

This menu indicates whether summer ventilation without bypass is possible. The menu can only be implemented if there is no bypass.

The following adjustments are made, () factory setting values.

- Temperature for activating the function (25.0 °C)
- Hysteresis (0.5 K)
- Inactive under (13.0 °C)



Symbol	Description	Explanation/Actions
	Status symbol Check mark	The status symbol check mark indicates the feasibility of the menu.
	Buttons Navigation	Temperature/hysteresis/inactive under Touch the navigation buttons to select (red text background) and confirm with the Enter button.
	Buttons + / -	Set the selected parameter with the +/- buttons.
	Buttons Enter Cancel/return	Confirm by touching the Enter button and exit the menu level via the Cancel/return button.

Table 34: Sub-menu Summer ventilation without bypass

The following switching conditions are available for the summer ventilation without bypass:

Parameters	Description of the parameters
T1:	Temperature of the outdoor air (t_aul) at the temperature sensor T1 of the unit
T3:	Temperature of the extract air (t_abl) at the temperature sensor T3 of the unit
t_som	Temperature limit for activation of the summer ventilation
t_aul_min:	limit value for the minimum outdoor temperature
H_som:	Hysteresis of the temperature limit for activation of the summer ventilation
Function	Switching conditions
ACTIVE, if:	$T1 < T3 \ \& \ T1 > t_aul_min \ \& \ T3 > t_som + H_som$

Table 35: Switching conditions for the summer ventilation

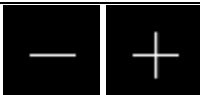
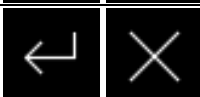
5.6.1.5 Sub-menu Ground heat exchanger shutter

In this menu, the presence of a GHE shutter (ground heat exchanger shutter) is shown.



Symbol	Description	Explanation/Actions	
		Button Check mark	By touching the check mark button, an existing GHE shutter is released.
		Button Cancel/return	Exit the menu levels by touching the cancel/return button until the start menu appears.

Table 36: Parametrisation ground heat exchanger shutter

5.6.1.6 Sub-menu Reset to factory data

In the sub-menu Reset to factory data, the unit can be reset to the factory data.



Symbol	Description	Explanation/Actions
 	Button Check mark	By touching the check mark button, the system is reset to the factory data.
	Button Cancel/return	Exit the menu levels by touching the cancel/return button until the start menu appears.

Table 37: Reset factory data

5.7 Service and maintenance



If regular maintenance work is not carried out on the CLIMOS unit, this will affect the functionality of the comfort ventilation.

Maintenance and repair by qualified personnel should be carried out by a maintenance service team on the basis of a maintenance contract. Maintenance and repair measures of the CLIMOS includes inspecting and cleaning the fans and heat exchanger. The heat exchanger should be cleaned based on how dirty it gets but the maintenance interval must not exceed two years.



Use checklist B to document the maintenance work completed.

5.7.1 Inspection and cleaning of the heat exchanger

In doing so, proceed as follows:

1. Disconnect the CLIMOS unit from the mains power supply.
2. If present, pull the red design filter cover **A** from the bracket of the casing lid.

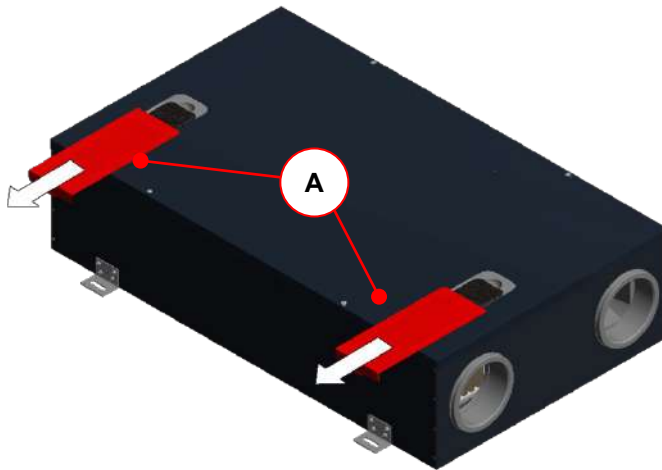

Fig. 44: Pulling out 2 design filter covers **A**

3. Open the quarter turn locks **B** by a 90° turn of the captive screw.

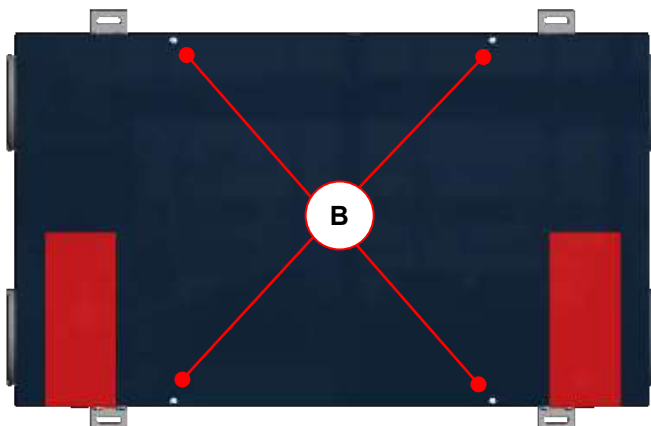

Fig. 45: Casing lid with 4 quarter turn locks **B**

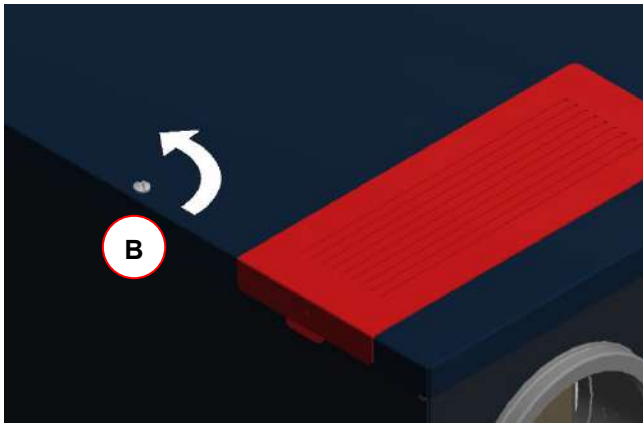

Fig. 46: Quarter turn lock with captive screw

4. Remove the casing lid **C** and pull the cable for the potential equalisation off the contact pin of the casing lid.

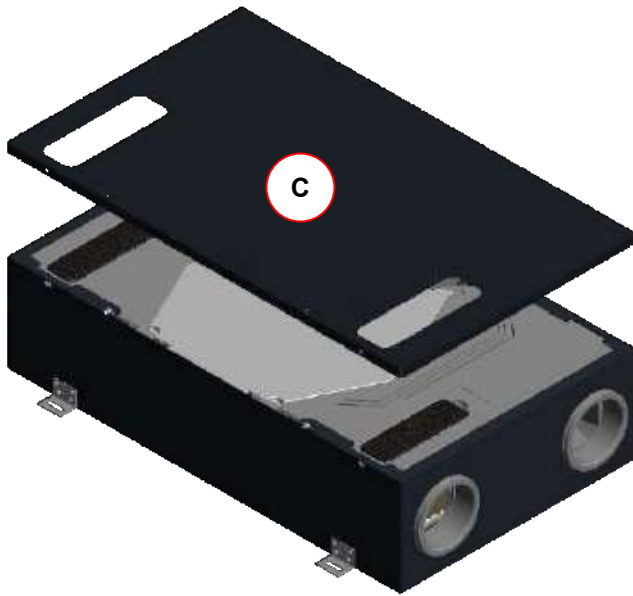

Fig. 47: Removing the casing lid **C** from the unit

5. Pull the holding clamps **D** (4x) vertically out of the EPP foam modules.

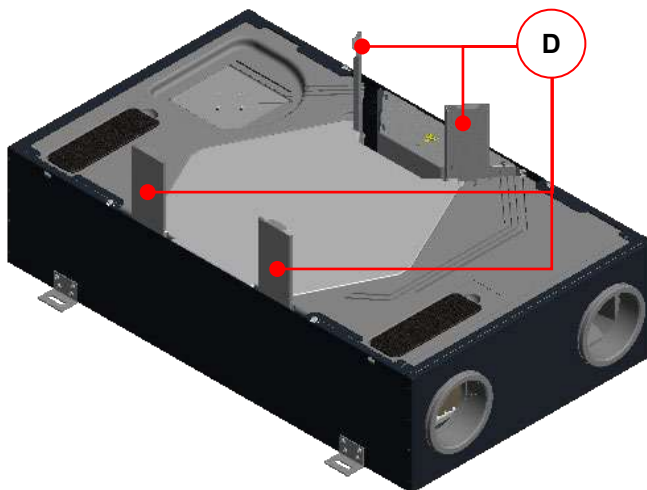

Fig. 48: Holding clamps **D** for positive fixation of the EPP foam modules

6. Push each fan box **F** approx. 3 - 4 mm in the direction of the ventilation tube connections in order for the heat exchanger box **G** to be released from the tongue-and-groove connection.

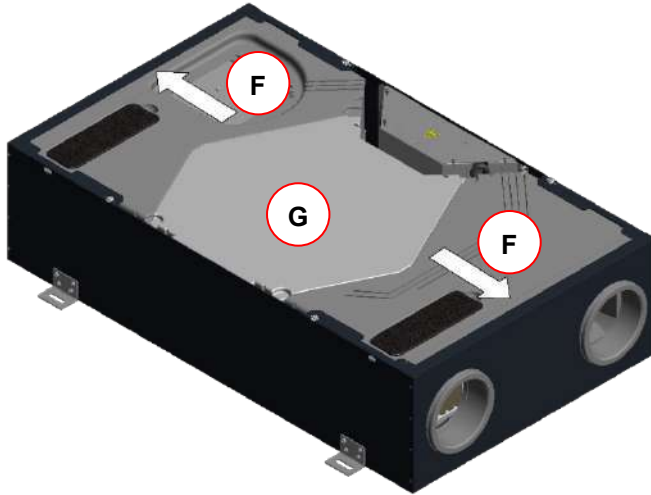

Fig. 49: Releasing the heat exchanger box **G** by pushing the fan boxes **F**



If the fan boxes **F cannot be moved, the ventilation tube connectors of the fan boxes must be shortened as follows!**

Cut through the all-round groove **H** (set cutting point) of the EPP connectors.

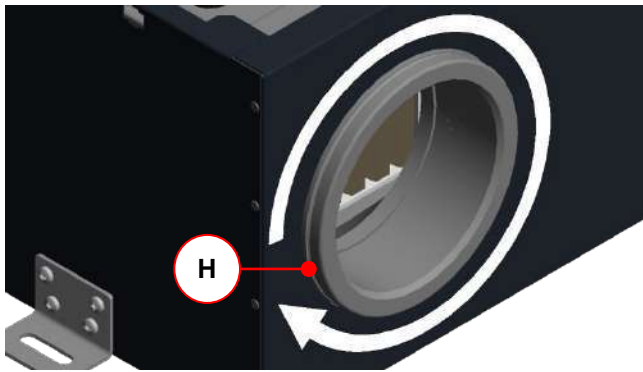

Fig. 50: Shortening the EPP- connectors at the set cutting point of the all-round groove



After completing the maintenance work, all disconnected ventilation tubes must be reconnected air-tight to the heat recovery system again. Provide a vapour-tight thermal insulation at the cutting points of the exterior and exhaust air connectors!

7. Pull the heat exchanger box **G** out vertically.

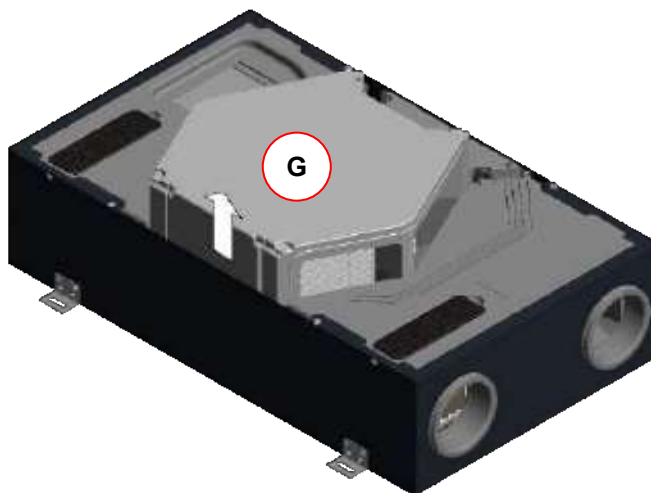

Fig. 51: Removing the heat exchanger box **G**

8. Clean the heat exchanger I located inside the heat exchanger box G if needed.

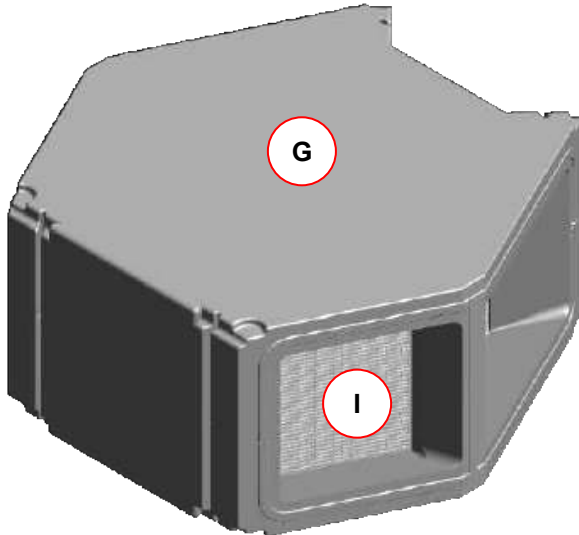



Fig. 52: Heat exchanger I in the heat exchanger box G

In doing so, proceed as follows:

- Dip the heat exchanger several times in warm water (max. 40 °C)
- Then rinse off the heat exchanger thoroughly with warm tap water (max. 40 °C)

Do  **not use aggressive or dissolving cleaning agents!**

- In order to dry it, position the heat exchanger such that residual water can run out of the openings
- Leave the heat exchanger to dry fully before reinstalling it



Instructions for proper disinfection can be found at www.core.life.

9. Using a vacuum cleaner, carefully vacuum the two suction casings J of the fan boxes and, in case of the unit version CLIMOS Comfort, vacuum the PTC heating elements of the integrated defroster with a suitable suction nozzle.



Do not touch any parts of the defroster by hand and do not damage the temperature sensor during cleaning!

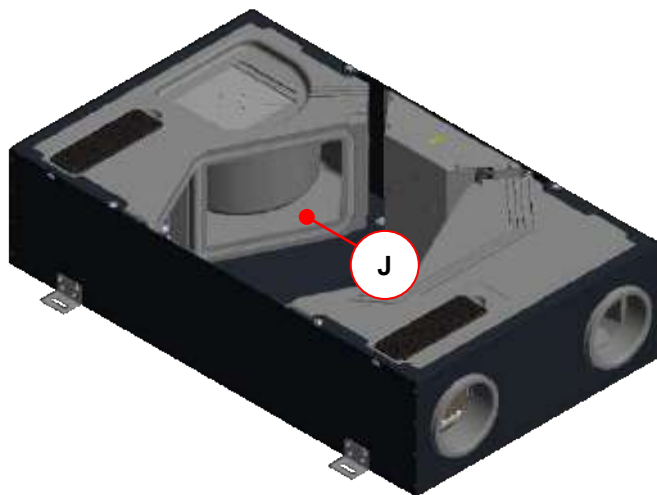

Fig. 53: Fan box suction casing J (2x)

10. Following the inspection, install all parts in reverse order.



When installing the heat exchanger box, make sure that it engages correctly with the fan boxes via the tongue-and-groove connection!

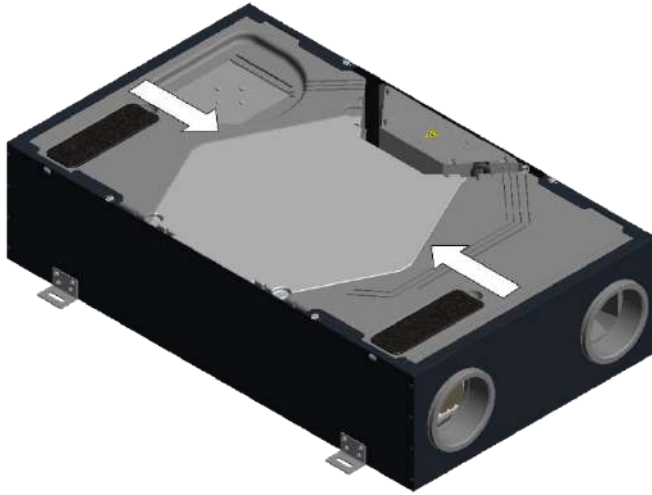

Fig. 54: Moving direction of the fan boxes for engaging with the heat exchanger box

11. Connect the cables for the potential equalisation to the contact pin of the casing lid.
12. Close the casing lid by turning the 4 captive screws of the quarter turn locks by 90°.
13. Reconnect the unit to the mains.

5.8 Error display and troubleshooting

The unit control system is equipped with an internal system for recognizing faults. The error messages display and the error forecast are in line with the presentation possibilities of the connected control panel. As a reaction to an error status, the fans are shut down.

5.8.1 Error display with LED control panel

The display of errors with the LED control panel is according to point 4.2.1.2. In addition to indicating the error states, an LED code is generated via LED L1...L7, which displays the significance of the error in a binary fashion. Suggestions for the checks / measures for the potential elimination of the error status are given in Table 39. The following LED combinations for displaying the error codes marked with "x" apply:

LED combination							Error Message	Possible cause
L1	L2	L3	L4	L5	L6	L7		
x		x					Supply air temperature is too low	minimal supply air temperature < nominal value
x	x		x	x		x	BUS version incompatible	Software versions of the components not compatible
		x	x	x		x	Too many units connected	Too many components connected to the BUS
x		x	x	x		x	Fan slave not connected	Missing BUS communication
	x	x	x	x		x	Fan slave communication error	Missing BUS communication
x	x	x	x	x		x	Defroster communication error	Missing BUS communication
					x	x	Heating register communication error	Missing BUS communication
x					x	x	Communication error ground heat exchanger shutter	Missing BUS communication
	x				x	x	General communication error	Missing BUS communication
x	x				x	x	Heater does not go off	BUS thermostat error
	x		x	x			General GHE error	Missing BUS communication with the control panel (GHE)

Table 38: Overview binary error encoding with LED control panel

5.8.2 Error displays with TFT control panel

On the TFT control panel, errors are displayed by plain text error messages. The last three occurred errors are registered with their date and time according to the event in the main menu Information/last messages. In addition to this message, a yellow warning triangle blinks on the top right edge of the screen.

The following clear text error messages are displayed:

Error Message	Possible cause	Checks/Measures
Sensor 1 sensor error	Sensor disruption or temperature sensor short circuit T1	Check detector or replace sensor
Sensor 2 sensor error	Sensor disruption or temperature sensor short circuit T2	Check detector or replace sensor
Sensor 3 sensor error	Sensor disruption or temperature sensor short circuit T3	Check detector or replace sensor
Sensor 4 sensor error	Sensor disruption or temperature sensor short circuit T4	Check detector or replace sensor
Supply air temperature is too low	minimal supply air temperature < nominal value	Supply air temperature > nominal value + 1 K
Outdoor temperature too low	Current outdoor air temperature < nominal value; longer than 30 min	Outdoor air temperature > nominal value; control after 1 h
Error fan 1 HALL	Supply air fan reports no rotational speed	Manual setting of a fan speed
Error fan 2 HALL	Exhaust air fan reports no rotational speed	Manual setting of a fan speed
BUS version incompatible	Software versions of the components not compatible	Replace software versions
Too many units connected	Too many components connected to the BUS	Remove excessive components
Fan slave not connected	Missing BUS communication	Connect fan slave
Fan slave communication error	Missing BUS communication	Check BUS communication
Defroster communication error	Missing BUS communication	Check BUS communication
Heating register communication error	Missing BUS communication	Check BUS communication
Communication error ground heat exchanger shutter	Missing BUS communication	Check BUS communication
General communication error	BUS components of the control device are not recognized	Disconnect from mains, then restart
Heater does not go off	BUS thermostat error	Replace BUS thermostat
General GHE error	Missing BUS communication with the control panel (GHE)	Check BUS communication

Table 39 Overview error messages, displays and troubleshooting with TFT control panel

5.9 Technical description

5.9.1 Type versions

CLIMOS Basic – R (right - type A) / L (left - type B)

Ventilation unit with cross-counterflow enthalpy exchanger without integrated defroster

CLIMOS Comfort – R (right - type A) / L (left - type B)

Ventilation unit with cross-counterflow enthalpy exchanger with integrated defroster

5.9.2 Air connections of the versions

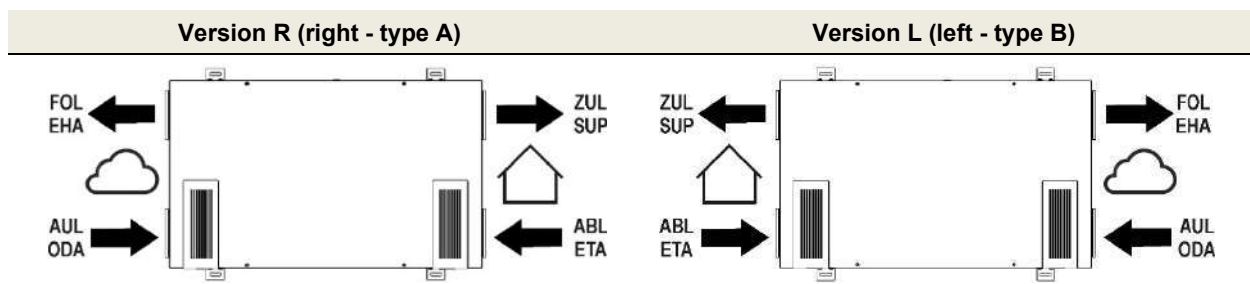

Table 40: Arrangement of air connections according to type R (right - type A) / L (left - type B)

5.9.3 Technical specification

General specifications	Description / Value
Heat exchanger type	Enthalpy exchanger with polymer membrane
Housing / Interior lining	Galvanised sheet steel, powder-coated, free of thermal bridges; interior lining is made of expanded polypropylene (EPP) to provide thermal and sound insulation
Pipe connections	DN 125 (sleeve size)
Weight	30 kg
Electrical connection	230 VAC, 50-60 Hz; 2 m mains cable with non-heating device plug connection
Connection power	0.14 / 0.75 kW (without / with defroster)
Protection class	I
Degree of protection	IP 30
Temperature range for transport and storage	-20 to 50 °C
Temperature range for moving air	-20 to 50 °C
Temperature range at the mounting location	Permanently frost-free
Installation positions	Suspended from the ceiling or reclined (horizontal) Suspended on the wall (horizontal or vertical) exhaust air connection must always be on top! Suspended sloped on the wall (horizontal or vertical) exhaust air connection must always be on top!

Table 41: General specifications

Operation data	Value
Volume flow	50 to 200 m ³ /h
Efficiency criterion	0.40 Wh/m ³ (at 111 m ³ /h / 100 Pa)
Waste heat recovery according to PHI	84% (at 111 m ³ /h / 100 Pa)
Heat output according to DIN 4719	111% (at 112 m ³ /h / 100 Pa)
Sound pressure level, distance of 3 m (unit emission according to DIN EN ISO 3743-1)	38 dB(A) (at 100 m ³ /h / 100 Pa) 42 dB(A) (at 200 m ³ /h / 100 Pa)

Table 42: Operation data

Certificates, approvals	CLIMOS F 200 Comfort	CLIMOS F 200 Basic
	Passivhaus certificate	
	Certificate according to DIN 4719	
	DIB approval AbZ Z-51.3-380	

Table 43: Certificates/ approvals

$p\dot{V}$ characteristic curve

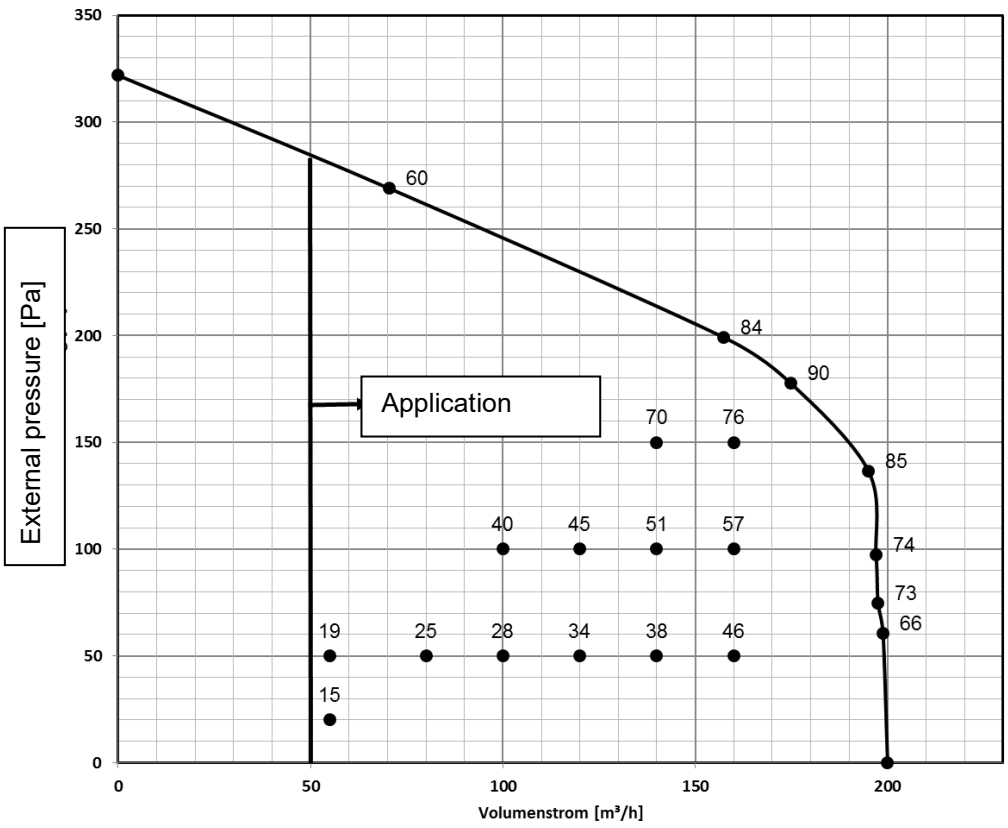

Note:

The numerical values shown in the $p\dot{V}$ characteristic curve diagram indicate the power consumption in [W] for the respective operating points without activated defroster.

Table 44: Diagram 2, $p\dot{V}$ characteristic curve CLIMOS

5.9.4 Dimensions

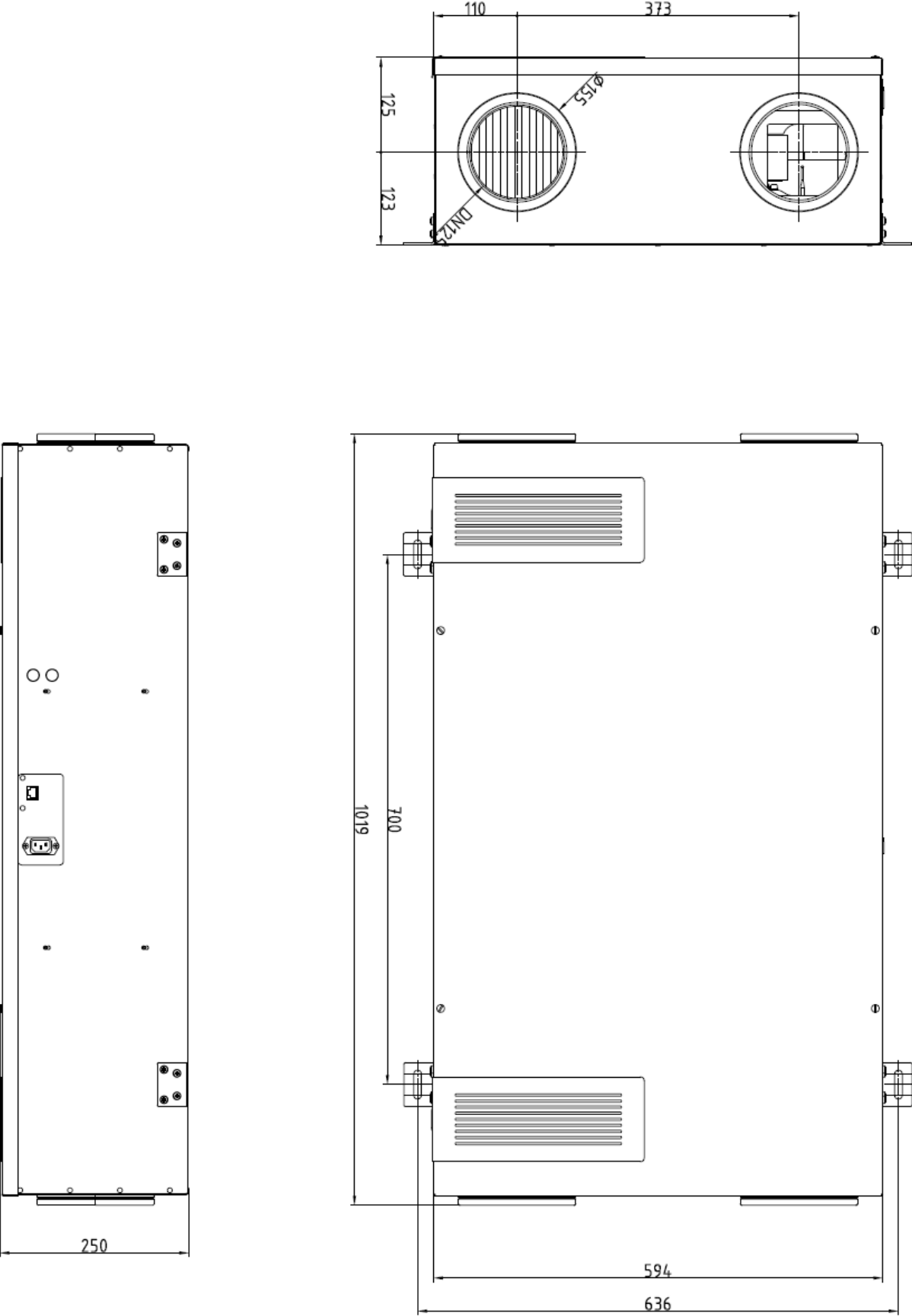

Fig. 55: Dimensional drawing CLIMOS

5.9.5 Circuit diagram CLIMOS Basic series

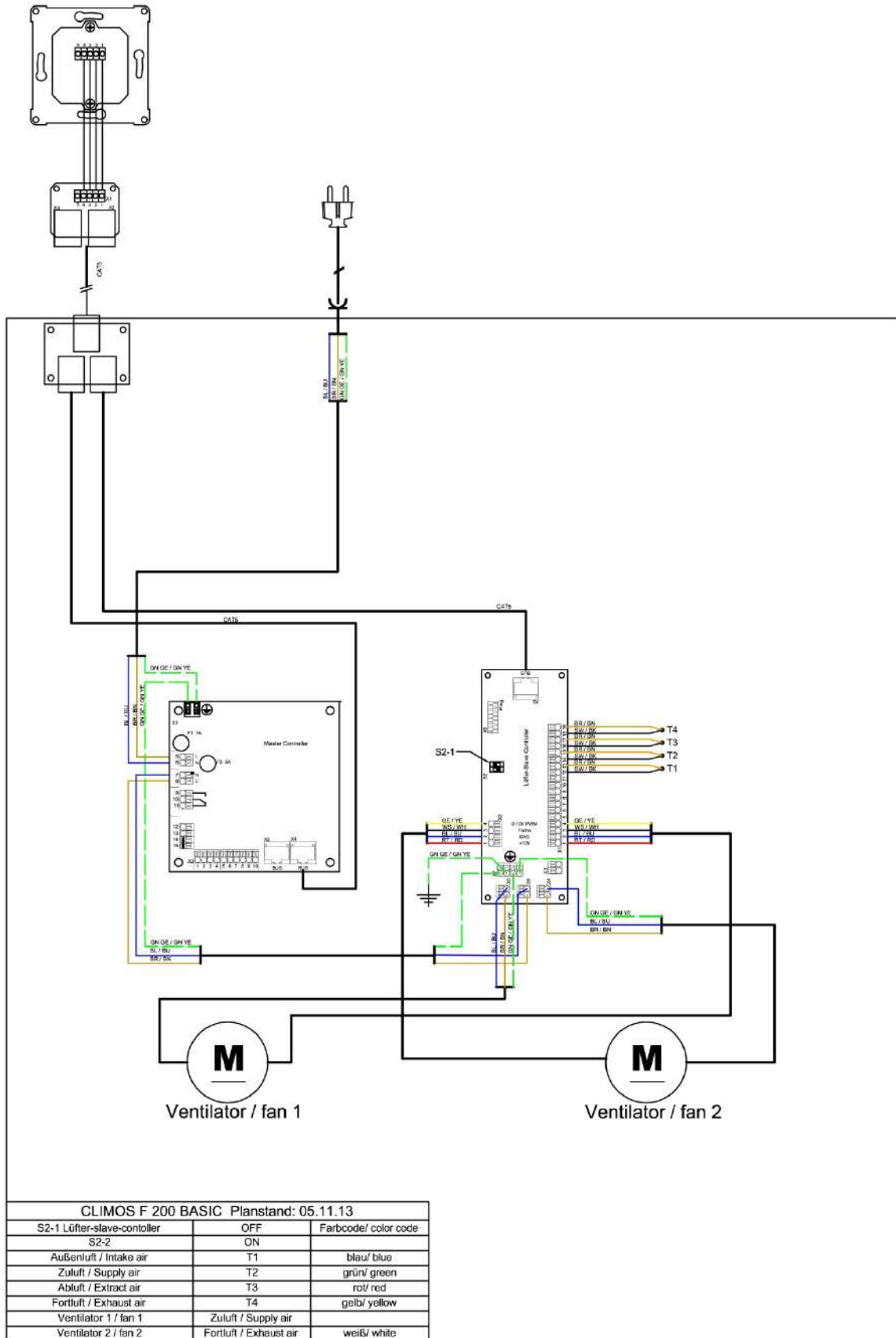

Fig. 56: Terminal assignment circuit diagram CLIMOS Basic

5.9.6 Circuit diagram CLIMOS Comfort series

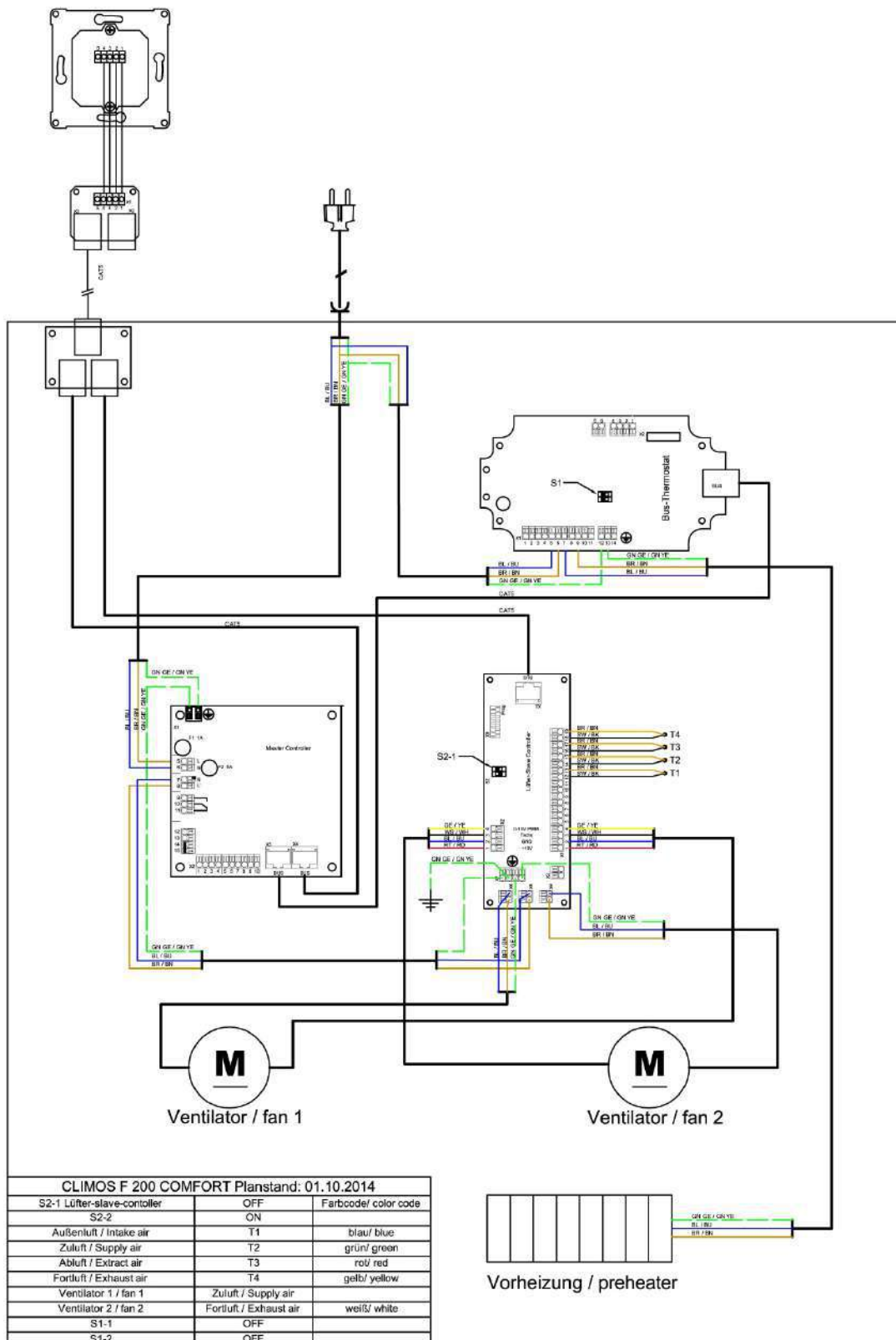

Fig. 57: Terminal assignment circuit diagram CLIMOS Comfort

5.9.7 Master Controller terminal assignment

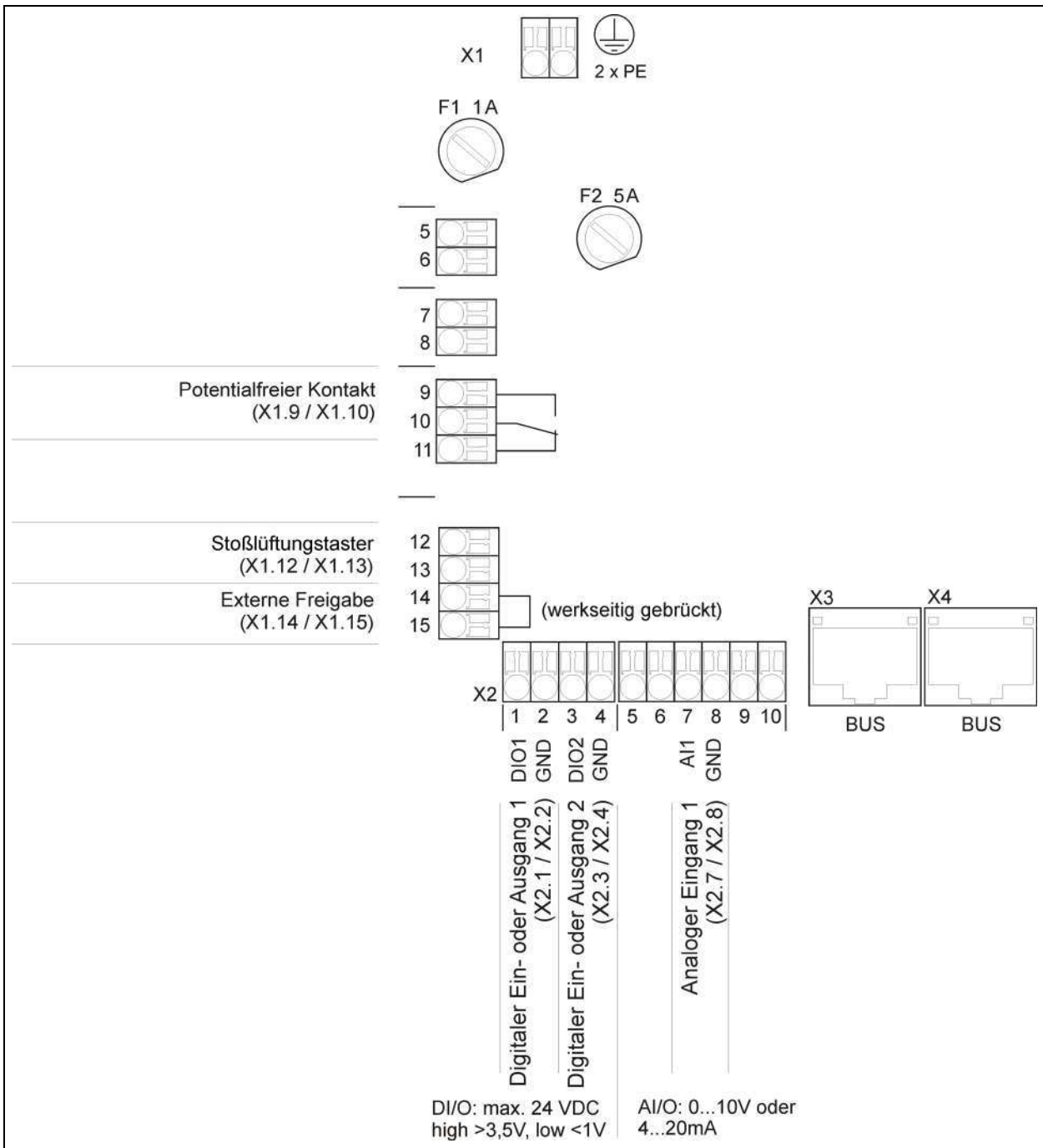

Fig. 58: Master-Controller terminal assignment

6 Appendices

6.1 Checklist A Maintenance work for users

Maintenance work				
Enter date in quarter				
1st Replace both filters in the ventilation unit (filter replacement cycle 90 days)				
Year \ Quarter	I	II	III	IV
20...				
20...				
20...				
20...				
20...				
20...				
20...				
20...				
20...				
20...				
20...				
2nd Extract air supplementary filter / clean the filters in extract air valves (filter replacement cycle approx. 2 months)				
Year \ Quarter	I	II	III	IV
20...				
20...				
20...				
20...				
20...				
20...				
20...				
20...				
20...				
20...				
20...				
20...				
3rd Replace other filters in the ventilation tube system				
Year \ Quarter	I	II	III	IV
20...				
20...				
20...				
20...				
20...				
20...				
20...				
20...				
20...				
20...				
20...				
20...				

6.2 Checklist B Maintenance work for qualified personnel

Maintenance work		Enter result						
<ul style="list-style-type: none"> - The listed maintenance work must be carried out in accordance with the components actually present. - Comments on status using informal protocol - Further annual tranches on separate sheet 								
No.	Components	Annually	Result	20...	20...	20...	20...	20...
1	Fan / ventilation unit	Cleaning of components carried out? - Fan - Enthalpy exchanger - Air-contacting surfaces on unit	yes / no					
		Frost protection / dew device operational?	yes / no					
		Structure-borne sound transmission, are fasteners avoided?	yes / no					
		Are status displays operational?	yes / no					
2	Electrical engineering / control	Cable connections and clamping assemblies secure?	yes / no					
		Are the regulating and control units functional?	yes / no					
3	Ventilation tube / heat insulation	Has cleaning (if necessary) been carried out? Testing OK? For cleaning when needed, see VDI 6022	yes / no					
		Heat insulation and moisture barrier OK?	yes / no					
		Are flexible connections between the unit and ventilation tube functional?	yes / no					
4	Fan, ventilation unit, filter, filter status	Stipulated filter class adhered to?	yes / no					
5	Fan / ventilation unit and fireplace if available	Safety feature with fireplace operational?	yes / no					
6	Extract air / supply air passage	Seat and locking provided?	yes / no					
		Stipulated filter class adhered to?	yes / no					
		Filter, filter status OK?	yes / no					
		Air volumes acc. to protocol OK?	yes / no					
7	Overflow air vents	Open cross section provided?	yes / no					
		No structure-borne and airborne sound transmission?	yes / no					

6.3 Commissioning and handover protocol

Customer data		
Family name:	First name:	Tel.:
Street:	Postcode:	Town/city:
Construction project:		
Unit type:	Serial no.:	Year of construction:

Completeness			
No.	Components	Version	Result
1	Supply air duct	- Design as planned - Cleaning option provided	yes / no yes / no
2	Supply air vents	- Arrangement as planned - Design as planned - Cleaning option provided	yes / no yes / no yes / no
3	Overflow air vents	- Arrangement as planned - Design as planned	yes / no yes / no
4	Extract air vents	- Arrangement as planned - Design as planned - Cleaning option provided	yes / no yes / no yes / no
5	Extract air duct	- Cleaning option provided	yes / no
6	Extractor fan	- Cleaning option provided	yes / no
7	Control / regulation system	- Operational	yes / no
8	Filter, optional	- Replacement or cleaning option provided	yes / no
9	Heat exchanger for waste heat recovery	- Cleaning option provided	yes / no
10	Documentation	- Available	yes / no

Function			
1	Operational with rated ventilation, as planned	Result OK Action required	yes / no yes / no
2	Switching steps possible, as planned	Result OK Action required	yes / no yes / no
3	Electrical power consumption	Result OK Action required	yes / no yes / no

Record of confirmation	
<p>Date: Signature/stamp:</p> <p style="text-align: right;">Commissioning personnel / installation technician</p>	

6.4 Air volume protocol

Customer data					
Family name:		First name:		Tel.:	
Street:		Postcode:		Town/city:	
Construction project:					
Unit type:		Serial no.:		Year of construction:	
Measurement data					
Measuring instrument used:		Faults during measurement:		Indoor temperature:	
				Outdoor temperature:	
Filter status when measuring	Outdoor	Extract	Building moisture status: % relative humidity without ventilation mode	Fan speed ratio Extract air / supply air:	
clean					
approx. ... days used					
very dirty					
Supply air				Fan speed: %	
No.	Room name	Project data		Measurement data	
		m ³ /h	m ³ /s	m ³ /h	m ³ /s
Extract air				Fan speed: %	
No.	Room name	Project data		Measurement data	
		m ³ /h	m ³ /s	m ³ /h	m ³ /s
P _{el} =		W			
<p>⇒ The listed measurement data must be determined in accordance with the components actually present.</p> <p>⇒ Reference has been made to the hygienic requirements for operating the ventilation system.</p> <p>⇒ Reference has been made to the influence of room air humidity for winter and summer operation.</p> <p>⇒ To safeguard warranty claims, only original parts (e.g. filters) are allowed to be used.</p>					
Date: Signatures:					
				Commissioning personnel / installation technician	
				User	

Deutschland (Germany)

Zehnder Group Deutschland GmbH
Almweg 34
77933 Lahr
T +49 7821 586 0
F +49 7821 586 223
info@zehnder-systems.de
www.zehnder-systems.de

**Zehnder Group Deutschland GmbH
Sales International**

Almweg 34
77933 Lahr
T +49 78 21 586 392
F +49 78 21 586 406
sales.international@zehndergroup.com
www.international.zehnder-
systems.com

France (France)

Zehnder Group Services SAS
7, rue Jean Mermoz,
Courcouronnes / Saint Guénault
91031 Evry Cedex
T +33 169 361 646
F +33 169 474 581
ventilation@zehnder.fr
www.zehnder.fr

Great Britain

Zehnder Group UK Ltd
Concept House Watchmoor Point
Camberley, Surrey
GU15 3AD
T +44 (0) 1276 605800
info@zehnder.co.uk
www.zehnder.co.uk

Italia (Italy)

Zehnder Group Italia S.r.l.
Via XXV Luglio, 6
Campogalliano (MO) 41011
T +39 059 978 62 00
F +39 059 978 62 01
info@zehnder.it
www.zehnder.it

Polska (Poland)

Zehnder Polska Sp. z o.o.
ul. Irysowa 1
55-040 Bielany Wrocławskie
T +48 71 367 64 24
F +48 71 367 64 25
info@zehnder.pl
www.zehnder.pl

Schweiz (Switzerland)

Zehnder Group Schweiz AG
Moortalstrasse 3
CH-5722 Granichen
T +41 62 855 11 11
F +41 62 855 11 22
info@zehnder-systems.ch
www.zehnder-systems.ch

España (Spain)

Zehnder Group Iberica IC, S.A.
Argenters, 7,
Parque Tecnológico del Vallès
08290 Cerdanyola (Barcelona)
T +34 90 210 61 40
F +34 93 582 45 99
info@zehnder.es
www.zehnder.es